

SCTE • ISBE
S T A N D A R D S

Digital Video Subcommittee

AMERICAN NATIONAL STANDARD

ANSI/SCTE 55-2 2019

**Digital Broadband Delivery System:
Out of Band Transport Part 2: Mode B**

NOTICE

The Society of Cable Telecommunications Engineers (SCTE) / International Society of Broadband Experts (ISBE) Standards and Operational Practices (hereafter called “documents”) are intended to serve the public interest by providing specifications, test methods and procedures that promote uniformity of product, interchangeability, best practices and ultimately the long-term reliability of broadband communications facilities. These documents shall not in any way preclude any member or non-member of SCTE•ISBE from manufacturing or selling products not conforming to such documents, nor shall the existence of such standards preclude their voluntary use by those other than SCTE•ISBE members.

SCTE•ISBE assumes no obligations or liability whatsoever to any party who may adopt the documents. Such adopting party assumes all risks associated with adoption of these documents, and accepts full responsibility for any damage and/or claims arising from the adoption of such documents.

Attention is called to the possibility that implementation of this document may require the use of subject matter covered by patent rights. By publication of this document, no position is taken with respect to the existence or validity of any patent rights in connection therewith. SCTE•ISBE shall not be responsible for identifying patents for which a license may be required or for conducting inquiries into the legal validity or scope of those patents that are brought to its attention.

Patent holders who believe that they hold patents which are essential to the implementation of this document have been requested to provide information about those patents and any related licensing terms and conditions. Any such declarations made before or after publication of this document are available on the SCTE•ISBE web site at <http://www.scte.org>

All Rights Reserved

© Society of Cable Telecommunications Engineers, Inc. 2019
140 Philips Road
Exton, PA 19341

Table of Contents

1.	INTRODUCTION	3
1.1	Revision History	3
1.2	Acronyms	3
1.3	References	4
2.	DAVIC OUT OF BAND AND UPSTREAM SIGNALING	5
2.1	Downstream Physical Interface Specification	6
2.1.1	Quaternary Phase Shift Keying (QPSK)	7
2.1.2	Coaxial Cable Impedance	11
2.1.3	Framing Structure	11
2.1.4	Signaling Link Extended Superframe (SL-ESF) Framing Forms	11
2.1.5	SL-ESF Frame Overhead	12
2.1.6	ESF Frame Alignment Signal	12
2.1.7	ESF Cyclic Redundancy Check	12
2.1.8	ESF M-bit Data Link	13
2.1.9	SL-ESF Frame Payload Structure	14
2.1.10	Definition of Slot Configuration Fields	17
2.1.11	ATM Cell Structure	21
2.2	Upstream Physical Interface Specification	22
2.2.1	Quaternary Phase Shift Keying (QPSK)	22
2.2.2	Coaxial Cable Impedance	26
2.2.3	Time Division Multiple Access (TDMA)	26
2.2.3.1	Slot Definition	26
2.2.3.2	Slot Definition Assignment	27
2.2.4	Contention Based Access	27
2.2.4.1	Slot Definition	28
2.2.4.2	Positive Acknowledgment	28
2.2.5	Relationship between Downstream MAC Control Channels and Upstream Channels	28
2.2.6	Slot Location and Alignment for the QPSK Upstream Channels	28
2.2.6.1	Upstream Data Rate - 1.544 Mbps/s	29
2.2.6.2	Upstream Data Rate - 256 kbit/s	29
2.2.6.3	Upstream Data Rate - 3.088 Mbps/s	30
2.3	Media Access Control Functionality	31
2.3.1	MAC Reference Model	31
2.3.2	Upstream and Downstream Channel Types	32
2.3.2.1	Downstream Out of Band Channel Requirements	32
2.3.2.2	Upstream Channel Requirements	32
2.3.3	MAC Information Transport	32
2.3.4	MAC Message Types	34
2.3.4.1	MAC Initialization, Provisioning and Sign On	34
2.3.4.1.1	Initialization and Provisioning	35
2.3.4.1.2	Sign On and Calibration	35
2.3.4.2	Connection Management	37
2.3.4.2.1	Connection Establishment	37
2.3.4.2.2	Connection Release	40
2.3.4.3	MAC Link Management	41

2.3.4.3.1	Power and Timing Management	41
2.3.4.3.2	TDMA Allocation Management	41
2.3.4.3.3	Channel Error Management	42
2.3.4.4	MAC Message Definitions	42
2.3.4.4.1	Initialization, Provisioning and Sign On Messages	42
2.3.4.4.2	Connection Management Messages	50
2.3.4.4.3	Link Management Messages	61
2.3.4.4.4	MAC message timeouts	72

Table of Figures

FIGURE 2-1	SPECTRUM ALLOCATION FOR THE BI-DIRECTIONAL PHY ON COAX.....	5
FIGURE 2-2	SPECTRUM ALLOCATION FOR THE INTEGRATED UNIDIRECTIONAL AND BI-DIRECTIONAL PASSBAND PHY ON A SINGLE COAX.....	6
FIGURE 2-3	DHCT OOB TRANSCEIVER CONCEPTUAL BLOCK DIAGRAM	6
FIGURE 2-4	QPSK DOWNSTREAM TRANSMITTER POWER SPECTRUM	8
FIGURE 2-5	SL-ESF FRAME STRUCTURE.....	11
FIGURE 2-6	SL-ESF PAYLOAD STRUCTURE FORMAT	15
FIGURE 2-7	CONCEPTUAL DIAGRAM OF THE CONVOLUTIONAL INTERLEAVER AND DE-LEAVER	17
FIGURE 2-8	BOUNDARY DEFINITIONS	17
FIGURE 2-9	SLOT BOUNDARY DEFINITION FIELD VALUES.....	18
FIGURE 2-10	ADDITIONAL SLOT BOUNDARY DEFINITION FIELD VALUES FOR EXTENDED RANGE CONTROL STATUS.....	19
FIGURE 2-11	RELATIONSHIP OF US SLOT TO DS INDICATOR.....	20
FIGURE 2-12	ATM CELL STRUCTURE.....	21
FIGURE 2-13	QPSK UPSTREAM TRANSMITTER POWER SPECTRUM	23
FIGURE 2-14	UPSTREAM SLOT STRUCTURE	27
FIGURE 2-15	MAC REFERENCE MODEL.....	31
FIGURE 2-16	INITIALIZATION AND PROVISIONING SEQUENCE	35
FIGURE 2-17	SIGN-ON MESSAGING SEQUENCE	36
FIGURE 2-18	STATE DIAGRAM FOR RANGING AND CALIBRATION.....	37
FIGURE 2-19	CONNECTION ESTABLISHMENT SIGNALING SEQUENCE.....	39
FIGURE 2-20	CONNECTION RELEASE SIGNALING.....	41

Table of Tables

TABLE 1-1:	ACRONYMS	3
TABLE 2-1	QPSK DOWNSTREAM TRANSMITTER POWER SPECTRUM	8
TABLE 2-2	SPECIFICATIONS FOR QPSK MODULATION (DOWNSTREAM)	9
TABLE 2-3	EXTENDED SUPERFRAME OVERHEAD STRUCTURE	12
TABLE 2-4	QPSK UPSTREAM TRANSMITTER POWER SPECTRUM	22
TABLE 2-5	SPECIFICATIONS FOR QPSK MODULATION (UPSTREAM)	23
TABLE 2-6	DAVIC MAC MESSAGES	34
TABLE 2-7	MAC MESSAGE TIMEOUTS	72

1. Introduction

1.1 Revision History

This document is identical to SCTE 55-2 2008 except for informative components which may have been updated such as the title page, NOTICE text, headers and footers. No normative changes have been made to this document.

Revision History

Revision	Date	Editor	DESCRIPTION
0.0	June 26, 1998		QPSK Out of Band Channels based on DAVIC, first draft
1.0	September 9, 1999	J. Bagley	Changed typo of DAVIC 1.1 to DAVIC 1.2
2.0	March 10, 2000	J. Bagley	Clarification and editorial changes

1.2 Acronyms

Table 1-1 provides a definition of the acronyms used throughout this document.

Table 1-1: Acronyms

AAL	ATM Adaptation Layer	CDT	Carrier Definition Table	DS-3	Digital Signal Level 3
AAL1	ATM Adaptation Layer 1	CF	Continuous Feed	DSM-CC/DSMCC	Digital Storage Media Command and Control
AAL5	ATM Adaptation Layer 5	CFS	Continuous Feed Session	DVB-ASI	Digital Video Broadcasting Asynchronous Serial Interface
ACK	Acknowledge	CM	Configuration Management	DVB	Digital Video Broadcasting (European)
ACS	Access Control and Security	CMB	CRC Message Block	DVSG	Digital Video Software Group
AG	Administrative Gateway	CMIP	Common Management Information Protocol	EA	Entitlement Agent (PowerKEY)
AHE	Analog Headend	CMIS	Common Management Information Service	EAI	External Alarm Interface
AMS	Alarms Management Subsystem	CMS	Customer Management System	ECM	Entitlement Control Message
AM-VSB	Amplitude Modulation- Vestigial-Sideband	CORBA	Common Object Request Broker Architecture	EIA	Electronic Industries Association
API	Applications Programmatic Interface	CRC	Cyclical Redundancy Check	EID	Entitlement Identifier
ARP	Address Resolution Protocol	CS	Convergence Sublayer	EM	Element Manager . Generically, any control software that manages hardware elements.
ASN	Abstract Syntax Notation	CW	Control Word	EMM	Entitlement Management Message
ATM	Asynchronous Transfer Mode	DAP	Directory Access Protocol	ENT	Entitlement Name Table
ATSC	Advanced Television System Committee	DAVIC	Digital Audio Visual Council	EPG	Electronic Program Guide
BASS	Business Applications Support System	DBAPI	Database Application Programming Interface	ESBI	External Status and Billing Interface
BCS	Broadcast Control Suite	DBDS	Digital Broadband Delivery System	ESF	Extended Super Frame
BFS	Broadcast File Server	DBS	Digital Broadcast Service	EUT	Entitlement Unit Table
BM/G	Broadband Multiplexer/Gateway	DCT	Display Channel Table	FAS	Frame Alignment Signal
BMM	Broadcast Manager Module	DES	Digital Encryption Standard	FAT	Forward Applications Transport
BOOTTERM	Boot Terminal	DHCT	Digital Home Communications Terminal	FDDI	Fiber Data Distribution Interface
BOSS	Business Operations Support System	DHCTSE	Digital Home Communications Terminal Secure Element	FDM	Frequency Division Multiplexed
BPS	Bits per second	DHEI	Digital Headend Extended Interface	FEC	Forward Error Correction
CA	Conditional Access	DIS	Digital Interactive Service	FPM	Forward Purchase Messages
CAA	Conditional Access Authority (PowerKEY)	DMS	Digital Multicast Service	FTP	File Transfer Protocol
CAM	Conditional Access Manager	DMSI	Digital Multicast Service Information	GBAM	Global Broadcast Authenticated Message
CAT	Conditional Access Table	DNCS	Digital Network Control System	GOP	Group Of Pictures
CATV	Cable Television			GPS	Global Positioning System
CCM	Continues Code Management				
CDN	Cable Digital Network				

GUI	Graphical User Interface
HEC	Headend Code
HEX	Hexadecimal
HFC	Hybrid Fiber Coax
HID	Hub ID
HRC	Harmonically Related Carrier
IANA	Internet Assigned Number Authority
IBDS	Interactive Broadband Delivery System
ID	Identifier
IDL	Interface Definition Language
IETF	Internet Engineering Task Force
IGU	Integrated Gateway Unit
IP	Internet Protocol
IPA	Internet Protocol Address
IPPV	Impulse Pay Per View
IRC	Incrementally Related Carrier
ITU	International Telecommunications Union
IVSN	Interactive Video Services Network
IXC	Inter-Exchange Carrier
L1	Level 1
LAN	Local Area Network
LCR	Local Clock Reference
LCT	Logical Channel Table
LDAP	Lightweight Directory Access Protocol
LOC	Line of Code
LUG	Line Up Group
MAC	Media Access Control
Mbps	Mega-bits per second
MHz	Mega-Hertz
MIB	Management Information Base
MMDS	Multi-Megabyte Digital Service
MMT	Modulation Mode Table
MPEG	Moving Pictures Expert Group
MSK	Multi-Session Key
MUX	Multiplexer
N/A	Not Applicable
NAK	Not Acknowledged
NE	Network Element
NFS	Network File System
NI	Network Inventory
NIC	Network Information Center
NIT	Network Information Table
NMS	Network Management System
NSAP	Network Service Access Point
NTP	Network Time Protocol
NTSC	National Television System Committee
NVOD	Near Video On Demand
NVSC	Non-Volatile Storage Cell
OC-3	Optical Carrier Level 3
OMG	Object Management Group
OMS	Object Management Server
ONC	Open Network Computing
OQPSK	Offset Quadrature Phase Shift Keying
ORB	Object Request Broker
OS	Operating System
OSF	Operations System Functions
OSI	Open System Interconnect
OSS	Operations Support System
OUI	Organization Unique Identifier
PA	Physical Address
PAT	Program Association Table
PCR	Program Clock Reference

PDU	Payload Data Unit
PEN	Private Enterprise Number
PES	Packetized Elementary Stream
PID	Process ID
PIN	Personal Identification Number
PKCS	Public Key Cryptography Standards
PKYCS	Power Key Control Suite
PMT	Program Map Table
POSIX	Portable Operating System Interface Unix
POTS	Plain Old Telephone Service
PPV	Pay Per View
PRBS	Pseudo-Random Bit Stream
PS	Program Stream
PSI	Program Specific Information
PVC	Permanent Virtual Circuit
QAM	Quadrature Amplitude Modulation
QPSK	Quadrature Phase Shift Keying
RDBMS	Relational Database Management System
RF	Radio Frequency
RPC	Remote Procedure Call
RS	Reed-Solomon (coding)
SAR	Subassembly and Reassembly
SAR-PDU	Subassembly and Reassembly Protocol Data Unit
SET	Secure Electronic Transaction
Sev	Severity
SG	Service Gateway
SI	Service Information
SID	Session Identifier
SLIP	Serial Line Internet Protocol
SM	System Manager
SMS	Subscriber Management System
SMI	Structure of Management Information
SN	Sequence Number
SNP	Sequence Number Protection
SNMP	Simple Network Management Protocol
SNVM	Secure Non-Volatile Memory
SONET	Synchronous Optical Network
SP	Service Provider
SPE	Synchronous Payload Envelope
SRM	Session and Resource Manager
SSL	Secure Sockets Layer
STS-3c	Synchronous Transport Signal level 3 concatenation (155.552 Mbps)
SW	Software
SWIF	Single Wire Interface
TCP	Transport Control Protocol
TCP/IP	Transport Control Protocol/Internet Protocol
TDMA	Time Division Multiple Access
TED	Transition Encryption Decryption
TLI	Transport Level Interface
TMN	Telecommunications Management Network
TS	Transport Stream
UDP	User Datagram Protocol
UI	User Interface
UNISON	Uni-directional SONET
UPA	Ultra SPARC Port Architecture
UPS	Universal Power Supply
USID	Universal Service Identifier
VASP	Value-Added Service Provider
VBI	Video Blanking Interval

VCI	Virtual Circuit Indicator
VCR	Video Cassette Recorder
VCT	Virtual Channel Table
VOD	Video On Demand
VPI	Virtual Path Indicator
VSP	Video Service Provider
XDR	External Data Representation

1.3 References

Reference	Document
-----------	----------

Reference	Document
1	Digital Audio Visual Council 1.3.1 Specification part 8, "Lower Layer Protocols and Physical Interfaces" as of 19978(prior to any corrigenda) NOTE: This document has become ISO-16500-4.
2	ITU-T recommendation I.361, "B-ISDN ATM Layer Specification", November 1995
3	ITU-T recommendation I.363.5; "B-ISDN ATM Adaptation Layer specification: AAL5", August 1996

2. DAVIC Out of Band and Upstream Signaling

The following has been extracted from the DAVIC 1.3.1 part 8 [Ref. 1] specification: Section 7.8, Passband Bi-directional PHY on coax. This does not include or track the issuance of corrigenda.

This Physical Layer Interface supports transmission over radio frequency coax (up to 1GHz bandwidth). It is referred to as the bi-directional QPSK-link on HFC (Hybrid Fiber Coax).

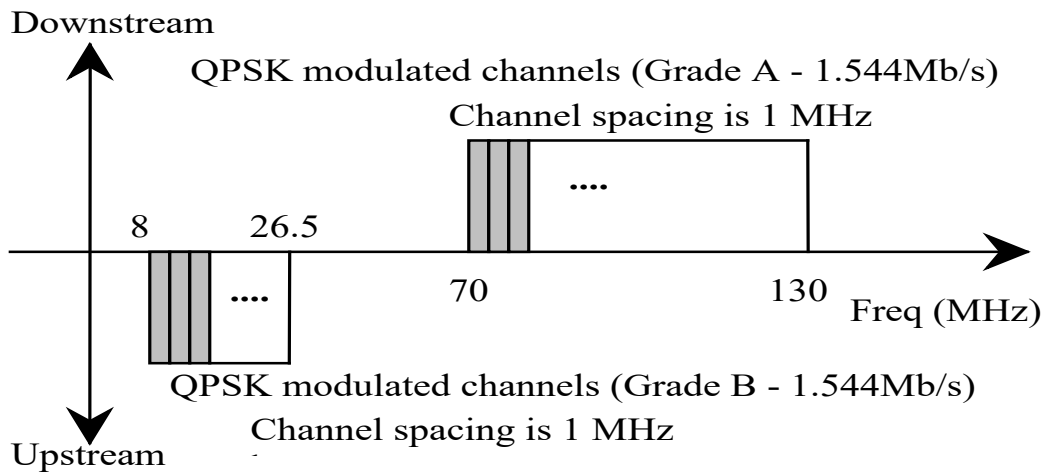

Figure 2-1 Spectrum Allocation For the Bi-directional PHY on Coax

This Physical Layer Interface describes the complete physical layer structure, i.e. framing structure, channel coding and modulation for each direction Downstream and Upstream). For the downstream QPSK modulation channel Grade A is mandatory and Grade B is optional. For the upstream QPSK channel Grade B is mandatory and Grades A and C are optional.

A summary of the spectrum allocation is depicted in

The Passband Bi-directional PHY on coax and the Passband Unidirectional PHY on coax may be used together on the same physical medium. Figure 2-2 shows the spectrum allocation in this case.

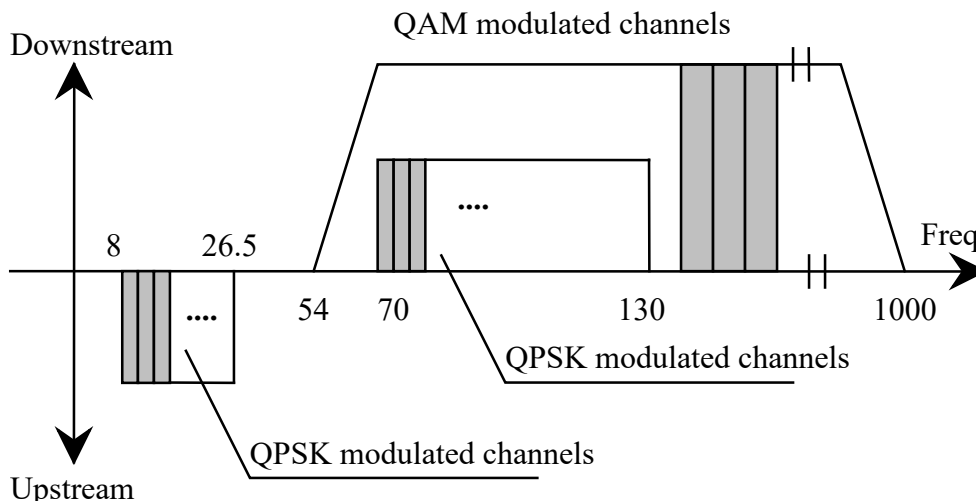

Figure 2-2 Spectrum allocation for the integrated unidirectional and bi-directional passband PHY on a single coax.

†

Conceptual block diagrams of the DHCT transceivers are shown in Figure 2-3 .

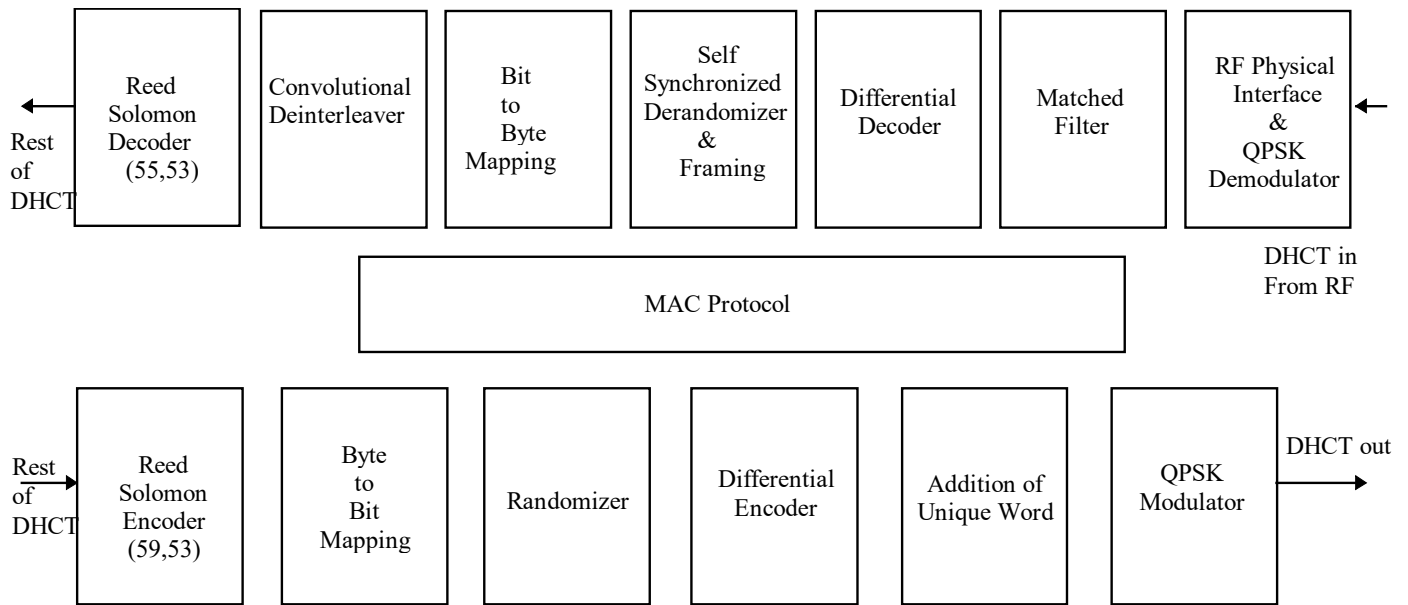

Figure 2-3 DHCT OOB Transceiver Conceptual Block Diagram

2.1 Downstream Physical Interface Specification

To carry downstream information a combination of quaternary phase shift keying (QPSK) and a framing structure are specified. QPSK is specified due to its increased error performance, its spectral efficiency, and its low peak to average power allow transmission at a high average power. The DAVIC specified Grade A QPSK is mandatory with Grade B being optional.

2.1.1 Quaternary Phase Shift Keying (QPSK)

QPSK modulation is used as a means of encoding digital information over wireline or fiber transmission links. The method is a subset of Phase Shift Keying (PSK) which is a subset of Phase Modulation (PM). Specifically QPSK is a four level use of digital phase modulation (PM). Quadrature signal representations involve expressing an arbitrary phase sinusoidal waveform as a linear combination of a cosine wave and a sine wave with zero starting phases.

The time-domain response of a square-root raised-cosine pulse with excess bandwidth parameter α is given by:

$$g(t) = \frac{\sin\left[\frac{\pi t}{T}(1-\alpha)\right] + \frac{4\alpha t}{T} \cos\left[\frac{\pi t}{T}(1+\alpha)\right]}{\frac{\pi t}{T} \left[1 - \left(\frac{4\alpha t}{T}\right)^2\right]}$$

where T is the symbol period.

The output signal shall be defined as

$$S(t) = \sum_n [I_n \cdot g(t - nT) \cdot \cos(2\pi f_c t) - Q_n \cdot g(t - nT) \cdot \sin(2\pi f_c t)]$$

with I_n and Q_n equal to ± 1 , independently from each other, and f_c the QPSK modulator's carrier frequency.

The QPSK modulator divides the incoming bit stream so that bits are sent alternately to the in-phase modulator I and the out-of-phase modulator Q. These same bit streams appear at the output of the respective phase detectors in the demodulator where they are interleaved back into a serial bit stream.

The QPSK signal parameters are:

RF bandwidth	$BW = (f_b / 2) * (1 + \alpha)$
Occupied RF Spectrum	$[f_c - BW/2, f_c + BW/2]$
Symbol Rate	$f_s = f_b / 2$
Nyquist Frequency	$f_N = f_s / 2$

with f_b = bit rate, f_c = carrier frequency and α = excess bandwidth.

For both bit rates: 1.544 Mbps/s (Grade A) and 3.088 Mbps/s (Grade B), the Power Spectrum at the QPSK transmitter shall comply to the Power Spectrum Mask given in Table 2-1 and

Figure 2-4. The Power Spectrum Mask shall be applied symmetrically around the carrier frequency.

Table 2-1 QPSK Downstream Transmitter Power Spectrum

$ (f - f_c) / f_N $	Power Spectrum
$\leq 1 - \alpha$	0 ± 0.25 dB
at 1	-3 ± 0.25 dB
at $1 + \alpha$	≤ -21 dB
≥ 2	≤ -40 dB

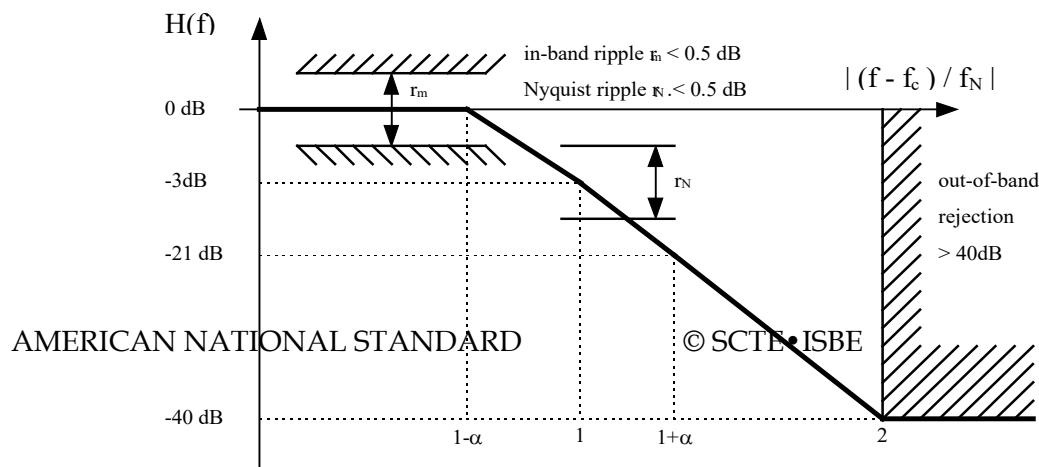

Figure 2-4 QPSK Downstream Transmitter Power Spectrum

QPSK systems require the use of differential encoding and corresponding differential detection. This is a result of the receivers having no method of determining if a recovered reference is a sine reference or a cosine reference. In addition, the polarity of the recovered reference is uncertain.

Differential encoding transmits the information in encoded phase differences between the two successive signals. The modulator processes the digital binary symbols to achieve differential encoding and then transmits the absolute phases. The differential encoding is implemented at the digital level.

The implementation of the QPSK (de)modulator shall comply to the specifications given in Table 2-2 Table 2-2 Specifications for QPSK Modulation (Downstream)

Table 2-2	Specifications for QPSK Modulation (Downstream)
Transmission Rate	1.544 Mbps/s for Grade A 3.088 Mbps/s for Grade B A QPSK demodulator shall support Grade A (B is optional)
Modulation	Differentially encoded QPSK.
Transmit Filtering	Filtering is $\alpha = 0.30$ square root raised cosine
Channel Spacing	1 MHz for Grade A 2 MHz for Grade B
Frequency Step Size	250 kHz (center frequency granularity)
Randomization	<p>After addition of the FEC bytes, MSB first byte to serial conversion is performed and then, all of the 1.544 Mbps/s or 3.088 Mbps/s data is passed through a six register linear feedback shift register (LFSR) randomizer to ensure a random distribution of ones and zeroes. The generating polynomial is: $x^6 + x^5 + 1$. Randomizer:</p>  <p>Serial Output</p> <p>A complementary self-synchronizing derandomizer is used in the receiver to recover the data. Derandomizer:</p>

Table 2-2	Specifications for QPSK Modulation (Downstream)															
	<p>Serial Input</p>  <p style="text-align: center;">D = 1 bit clock delay register</p> <p>Serial Output</p>															
Differential Encoding	<p>Bytes entering the byte-to-symbol encoder are divided into four bit pairs, each bit pair generating one QPSK symbol. Byte boundaries coincide with bit pair boundaries: that is, no bit pairs overlap two bytes. The bit pair corresponding to the MSBs of the byte is sent first. Within each bit pair, the more significant bit is referred to a 'A' and the less significant as 'B'. The differential encoder shall accept bits(A,B) in sequence, and generate phase changes as follows:</p> <table border="1" data-bbox="711 863 1075 1031"> <thead> <tr> <th>A</th> <th>B</th> <th>Phase Change</th> </tr> </thead> <tbody> <tr> <td>0</td> <td>0</td> <td>none</td> </tr> <tr> <td>0</td> <td>1</td> <td>+ 90 degrees</td> </tr> <tr> <td>1</td> <td>1</td> <td>180 degrees</td> </tr> <tr> <td>1</td> <td>0</td> <td>- 90 degrees</td> </tr> </tbody> </table> <p>Initialization: The differential encoder state at the start of the payload (equivalent to at the end of the preamble) must be [I,Q]=[01].</p>	A	B	Phase Change	0	0	none	0	1	+ 90 degrees	1	1	180 degrees	1	0	- 90 degrees
A	B	Phase Change														
0	0	none														
0	1	+ 90 degrees														
1	1	180 degrees														
1	0	- 90 degrees														
Signal Constellation	<p>The outputs I, Q from the differential encoder map to the phase states as follows:</p> 															
Carrier Center Frequency Range	70 to 130 MHz. The receiver shall operate over the entire specified frequency range.															
Frequency Stability	+/- 50 ppm measured at the upper limit of the frequency range															
Symbol Rate Accuracy	+/- 50 ppm															
Transmitter Power Spectrum Mask	A common mask for both bit rates: 1.544 Mbps/s (Grade A) and 3.088 Mbps/s (Grade B) is given in Table 2-1															
Carrier Suppression	> 30 dB															
I/Q Amplitude Imbalance	< 1.0 dB															
I/Q Phase Imbalance	< 2.0 degree															
Receive Power Level at the demodulator input (downstream)	42 - 75 dBmicroV (RMS) (75 Ohm)															

Table 2-2	Specifications for QPSK Modulation (Downstream)
out-of-band)	
C/N at the DHCT input (Nyquist bandwidth, white noise)	≥ 20 dB for BER $< 1 \times 10^{-10}$ (after R/S error correction) (i.e. 1 error in 2 hours at 1.5 Mbps/s) > 18 dB for BER $< 1 \times 10^{-6}$ before R/S error correction

2.1.2 Coaxial Cable Impedance

The coaxial cable nominal impedance shall be 75 Ohm over the frequency range as specified in.

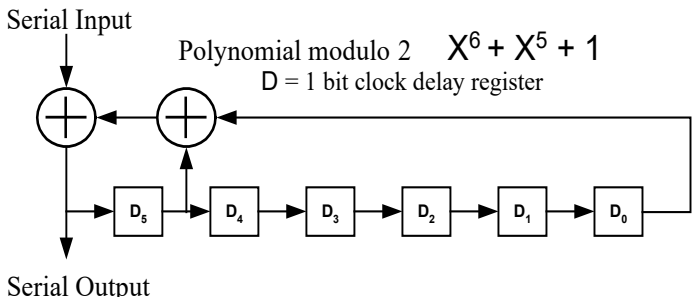
2.1.3 Framing Structure

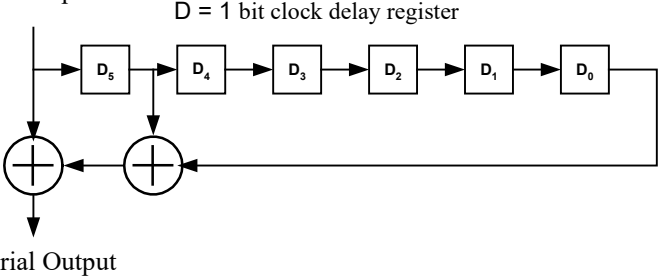
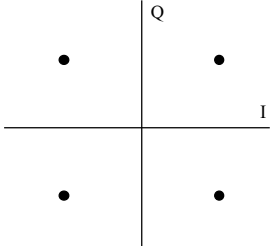
The framing organization shall be based on Signaling Link Extended Superframe (SL-ESF) format, an SL-ESF payload structure, and an ATM cell structure.

2.1.4 Signaling Link Extended Superframe (SL-ESF) Framing Forms

The Signaling Link Extended Superframe (SL-ESF) frame structure is illustrated in . The bitstream is partitioned into 4632 bit Extended Superframes. Each Extended Superframe consists of 24 193-bit frames. Each frame consists of 1 overhead (OH) bit and 24 bytes (192 bits) of payload.

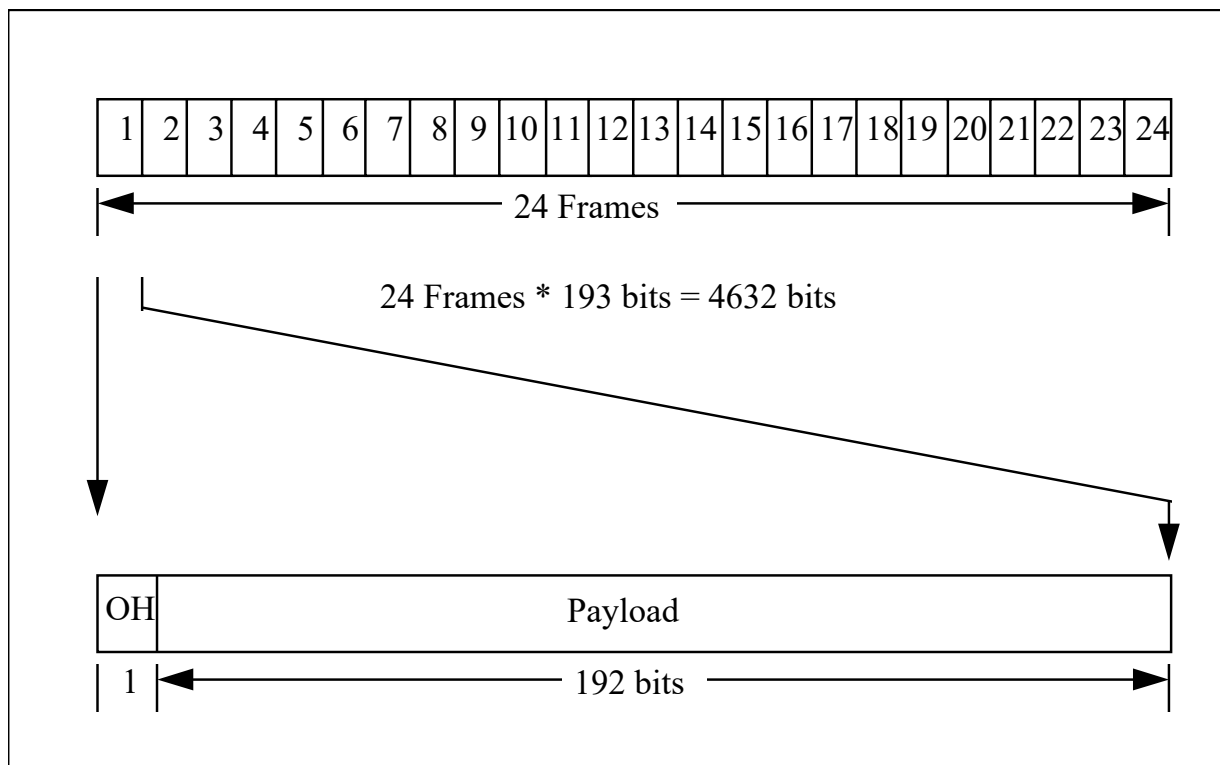

Figure 2-5 SL-ESF Frame Structure**2.1.5 SL-ESF Frame Overhead**

There are 24 frame overhead bits in the Extended Superframe which are divided into Extended Superframe Frame Alignment Signal (F1-F6), Cyclic Redundancy Check (C1-C6), and M-bit Data Link (M1-M12), as illustrated in Table 2-3.

Table 2-3 Extended Superframe Overhead Structure

Frame Number	Bit Number	Overhead Bit	Data (192 bits)	
1	0	M1		◆ Slot Position
2	193	C1		
3	386	M2		
4	579	F1 = 0		
5	772	M3		
6	965	C2		
7	1158	M4		
8	1351	F2 = 0		
9	1544	M5		◆ Slot Position
10	1737	C3		
11	1930	M6		
12	2123	F3 = 1		
13	2316	M7		
14	2509	C4		
15	2702	M8		
16	2895	F4 = 0		
17	3088	M9		◆ Slot Position
18	3281	C5		
19	3474	M10		
20	3667	F5 = 1		
21	3860	M11		
22	4053	C6		
23	4246	M12		
24	4439	F6 = 1		

FAS: Frame Alignment Signal (F1 - F6)

DL: Mbps Data Link (M1 - M12)

CRC: Cyclic Redundancy Check (C1 - C6)

2.1.6 ESF Frame Alignment Signal

The ESF Frame Alignment Signal (FAS) is used to locate all 24 frames and overhead bit positions. The bit values of the FAS are defined as follows:

F1 = 0, F2 = 0, F3 = 1, F4 = 0, F5 = 1, F6 = 1.

2.1.7 ESF Cyclic Redundancy Check

The Cyclic Redundancy Check field (Table 2-3) contains the CRC-6 check bits calculated over the previous Extended Superframe (CRC Message block [CMB] size = 4632 bits). Before calculation, all 24 frame overhead bits are equated to the value “1”. All information in the other bit positions is unchanged. The check bit sequence C1-C6 is the remainder after multiplication by x^6 and then division by the generator polynomial x^6+x+1 of the CMB. C1 is the most significant bit of the remainder. The initial remainder value is preset to all zeros.

2.1.8 ESF M-bit Data Link

The M-bits in the SL-ESF serve two purposes:

- to mark the slot positions for the upstream Contention based and Contentionless based signaling links
- to provide slot count information for upstream message bandwidth allocation management in the DHCT.

M-bits M1, M5, and M9 mark the start of an upstream slot position for upstream message transmission.

Think of M-bits M10 - M1 as a register, which counts from 0 to N, where N is an integer which indicates slot position cycle size (the value of N is sent in the MAC Default Configuration Message as Service_Channel_Last_Slot). The upstream slot position register indicates the upstream slot positions that will correspond to the next SL-ESF frame. Upstream slot positions are counted from 0 to N. There are 3 upstream slots per upstream slot position when the upstream data rate is 1.544 Mbps/s, there are 6 upstream slots per upstream slot position when the upstream data rate is 3.088 Mbps/s, and there is 0.5 upstream slot per upstream slot position when the upstream data rate is 256 kbit/s. The corresponding upstream slot rates are, therefore, 3000 upstream slots/sec when the upstream data rate is 1.544 Mbps/s, 6000 upstream slots/sec when the upstream data rate is 3.088 Mbps/s, and 500 upstream slots/sec when the upstream data rate is 256 kbit/s. The algorithm to determine the upstream slot position counter value is given below:

```
if (downstream_rate == 3.088 Mbps/s) {n = 1;}
else {n = 0;}
```

```
upstream_slot_position_register = value of M-bits latched at bit_position M11 (M10 - M1)
```

```
if (upstream_rate==1.544 Mbps/s) { m = 3;}
else if (upstream_rate==3.088 Mbps/s) {m = 6;}
else {m = 0.5}
```

```
if ( bit_position==M1 and previous M12 ==1)
{ upstream_slot_position_counter = upstream_slot_position_register * 3 * m; }
```

```
if ( bit_position == M5)
if ( (n == 0) or (n == 1 and previous M12 == 0) )
{ upstream_slot_position_counter = upstream_slot_position_counter+m; }
```



```

if (bit_position == M9)
if ( (n = 0) or (n = 1 and previous M12 == 1) )
{ upstream_slot_position_counter = upstream_slot_position_counter + m; }

if (bit_position == M11)
{ temp_upstream_slot_position_register = (M10, M9, M8, ..., M1); }

if ( (bit_position == M12 ) and ( M12 == 1) )
{upstream_slot_position_register = temp_upstream_slot_position_register;}

```

where, the M-bits (see Table 2-3) will be defined as follows:

M1 - M10 = 10 bit ESF counter which counts from 0 to N with M10 the most significant bit (MSB);

M11 = odd parity for the ESF counter, i.e., M11 = 1 if the ESF_value (M1-M10) has an even number of bits set to 1;

M12 = 1: ESF counter valid
0: ESF counter not valid

The values assigned to M12 are as follows:

(1) When the QPSK downstream channel bit rate is 1.544 Mb/s, the M12 bit, is always set to the value '1'.

(2) When the QPSK downstream channel bit rate is 3.088 Mb/s, the information is always transmitted in pairs of superframe, where superframe-A is the first superframe in the pair, and superframe-B is the second superframe in the pair. In this case, the M12 bit of superframe-A is set to the value '0' and the M12 bit of superframe-B is set to the value '1'.

2.1.9 SL-ESF Frame Payload Structure

The SL-ESF frame payload structure provides a known container for defining the location of the ATM cells and the corresponding Reed Solomon parity values. The SL-ESF payload structure is shown in Figure 2-6

1	← 2 →		← 53 →	← 2 →		
1	R1a	R1b	ATM Cell	RS parity		
2	R1c	R2a			R2b	
3	R2c	R3a				
4	R3b	R3c			R4a	
5	R4b	R4c				
6	R5a	R5b			R5c	
7	R6a	R6b				
8	R6c	R7a			R7b	
9	R7c	R8a				
10	R8b	R8c			T	T

Figure 2-6 SL-ESF Payload Structure Format

The SL-ESF payload structure consists of 5 rows of 57 bytes each, 4 rows of 58 bytes each which includes 1 byte trailer, and 1 row of 59 bytes, which includes a 2 byte trailer. The first bit of the SL-ESF payload structure follows the M1 bit of the SL-ESF frame. The SL-ESF payload fields are defined as follows.

The two T fields shall be set to 0 to facilitate future enhancements.

Rxa-Rxc is a 24 bit field containing slot configuration information for the related upstream channel "x" and is defined as:

$$\begin{aligned} Rxa &= (b0 \dots b7) \\ Rxb &= (b8 \dots b15) \\ Rxc &= (b16 \dots b23) \end{aligned}$$

$$\begin{aligned} \text{qpsk_x_slot_configuration} &= (b0 \dots b23) \\ &= \text{slot configuration information for the upstream} \\ &\quad \text{channel "x"} \end{aligned}$$

where

b0	= ranging control slot indicator for next 3ms period
b1-b6	= slot boundary definition field for next 3ms period
b7	= slot 1 reception indicator for second previous 3ms period
b8	= slot 2 reception indicator for second previous 3ms period
b9	= slot 3 reception indicator for second previous 3ms period
b10	= slot 4 reception indicator for second previous 3ms period
b11	= slot 5 reception indicator for second previous 3ms period
b12	= slot 6 reception indicator for second previous 3ms period
b13	= slot 7 reception indicator for second previous 3ms period
b14	= slot 8 reception indicator for second previous 3ms period
b15	= slot 9 reception indicator for second previous 3ms period
b16-17	= reservation control for next superframe
b18-b23	= CRC 6 parity (see definition in SL-ESF section)

When the upstream data channel is a 256 kbit/s data channel, then only the first three slot reception indicators are valid. These slots indicator refer to the three available slots which span over two 3ms period periods in the 256 kbit/s. When the upstream data channel is a 3.088 Mb/s data channel, two consecutive qpsk_slot_configuration fields are used. The definition of the first slot configuration field is unchanged. The definition of the second slot configuration field extends the boundary definition to upstream slots 10 through 18, and the reception indicators cover upstream slots 10 through 18.

When the Downstream MAC channel is a 3.088 Mbps/s data channel, the Slot Configuration fields in superframe-B are used when one or more 3.088 Mbps/s upstream QPSK channels are being utilized. The index for the overhead bytes in superframe-B will be R9a, R9b..., R16a, R16b, R16c.

Reed-Solomon encoding shall be performed on each ATM cell with T=1. This means that 1 erroneous byte per ATM cell can be corrected. This process adds 2 parity bytes to the ATM cell to give a codeword of (55,53).

The Reed-Solomon code shall have the following generator polynomials:

Code Generator Polynomial: $g(x) = (x + \mu^0)(x + \mu^1)$, where $\mu=02\text{hex}$

Field Generator Polynomial: $p(x) = x^8 + x^4 + x^3 + x^2 + 1$

Convolutional interleaving shall be applied to the ATM cells contained in the SL-ESF. The Rxa - Rxc bytes and the two T bytes shall not be included in the interleaving process. Convolutional interleaving is applied by interleaving 5 lines of 55 bytes.

Following the scheme of Figure 2-7, convolutional interleaving shall be applied to the error protected packets. The Convolutional interleaving process shall be based on the Forney approach, which is compatible with the Ramsey type III approach, with $I=5$. The Interleaved frame shall be composed of overlapping error protected packets and a group of 10 packets shall be delimited by the start of the SL-ESF.

The interleaver is composed of I branches, cyclically connected to the input byte-stream by the input switch. Each branch shall be a First In First Out (FIFO) shift register, with depth (M) cells (where $M = N/I$, $N = 55 =$ error protected frame length, $I =$ interleaving depth). The input and output switches shall be synchronized.

For synchronization purposes, the first byte of each error protected packet shall be always routed into the branch "0" of the interleaver (corresponding to a null delay). The third byte of the SL-ESF payload (the byte immediately following R1b) shall be aligned to the first byte of an error protected packet.

The deinterleaver is similar, in principle, to the interleaver, but the branch indexes are reversed (i.e. branch 0 corresponds to the largest delay). The deinterleaver synchronization is achieved by routing the third data byte of the SL-ESF into the "0" branch.

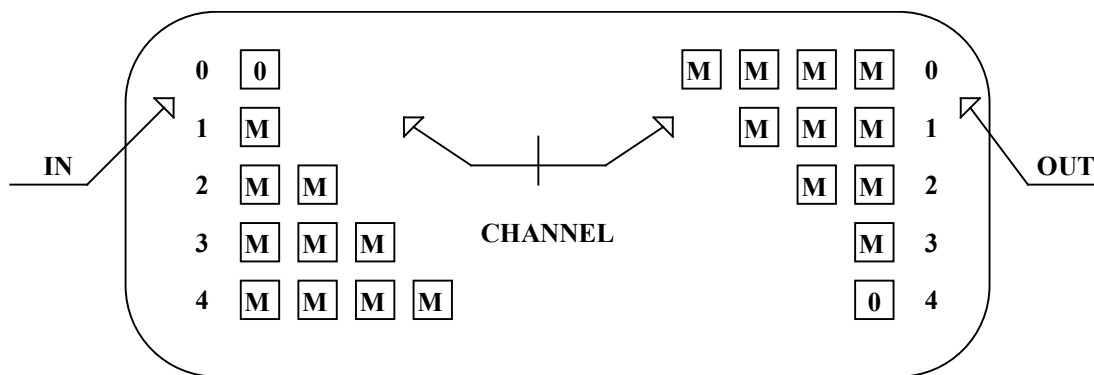

Figure 2-7 Conceptual Diagram of the Convolutional Interleaver and De-leaver

2.1.10 Definition of Slot Configuration Fields

Ranging Control Slot Indicator (b0) - When this bit is active ($b0 = 1$), the first three slots of upstream channel "x" which correspond to the occurrence of the next 3 msec period are designated as ranging control slots. A ranging control message may be transmitted in the second ranging control slot, and the first and third ranging control slots may not be used for transmission (guard band for ranging operations).

Slot Boundary Definition field (b1-b6) - Slot types are assigned to upstream slots using bits b0-b6. The slots are grouped into regions within the 3 msec period such that slots of a similar type are contained within the same region. The order of the regions is Ranging slot, Contention based slots, Reserved slots and Contentionless based slots. If a ranging slot is available within a 3 msec period it will consist of the first three slot times in the 3 msec period. A ranging slot is indicated by b0 = 1. The boundaries between the remaining regions of the 3 msec are defined by b1-b6. The boundaries are defined in Figure 2-8

Boundary 0	
Boundary 1	slot 1
Boundary 2	slot 2
Boundary 3	slot 3
Boundary 4	slot 4
Boundary 5	slot 5
Boundary 6	slot 6
Boundary 7	slot 7
Boundary 8	slot 8
Boundary 9	slot 9

Figure 2-8 Boundary Definitions

The boundary positions are defined by b1-b6 in Figure 2.9.,

row = Contention based/Reserved region boundary

column = Reserved packet/Contentionless based region boundary

(example : b0=0, b1-b6=22: Contention (1-2), Reserved (3-5), Contentionless (6-9))

	0	1	2	3	4	5	6	7	8	9
0*	0	1	2	3	4	5	6	7	8	9
1*		10	11	12	13	14	15	16	17	18
2*			19	20	21	22	23	24	25	26
3				27	28	29	30	31	32	33
4					34	35	36	37	38	39
5						40	41	42	43	44
6							45	46	47	48
7								49	50	51
8									52	53
9										54

(*) note: When the ranging control slot indicator (b0) is set to “1”, the values in rows 0 - 2 are illegal values, and values in row 3 means that there are no aloha slots, because slots 1-3 are defined as ranging control slots.

Figure 2-9 Slot Boundary Definition Field Values

The remaining values of the Slot Boundary Definition Field are provided in Figure 2-10 .

b1-b6 value	Ranging Control slots	Contention slots	reservation slots	Contentionless slots
55	1-6	7-9	-	-
56	1-6	7-8	-	9
57	1-6	7	8-9	-
58	1-6	7	8	9
59	1-6	7	-	8-9
60	1-6	-	7-8	9
61	1-6	-	7	8-9
62	1-6	-	-	7-9
63	1-6	-	-	-

Note: For b1-b6 = 55 - 63, b0 must be set to 1.

Figure 2-10 Additional Slot Boundary Definition Field Values for Extended Range Control Slots

The values in Figure 2-9 and Figure 2-10 are derived from b1-b6 in the following manner:

$$b1 + (b2 * 2) + (b3 * 4) + (b4 * 8) + (b5 * 16) + (b6 * 32)$$

When the upstream data channel is a 256 kbit/s data channel, then only the first three slot boundary positions are valid. In this case, only the first three rows and columns in Figure 2-9 are valid, and Figure 2-10 is not valid. When the upstream data channel is a 3.088 mbit/s data channel, each slot boundary definition field applies to 9 slots within the 3 msec period. In this case, there will be two slot boundary definition fields which define the 3 msec period.

Slot Reception Indicators (b7 - b15) - When a slot reception indicator is active (“1”), this indicates that a cell was received without collision. The relationship between a given US slot and its indicator is shown in Figure 2-11. When the indicator is inactive (“0”), this indicates that either a collision was detected or no cell was received in the corresponding upstream slot.

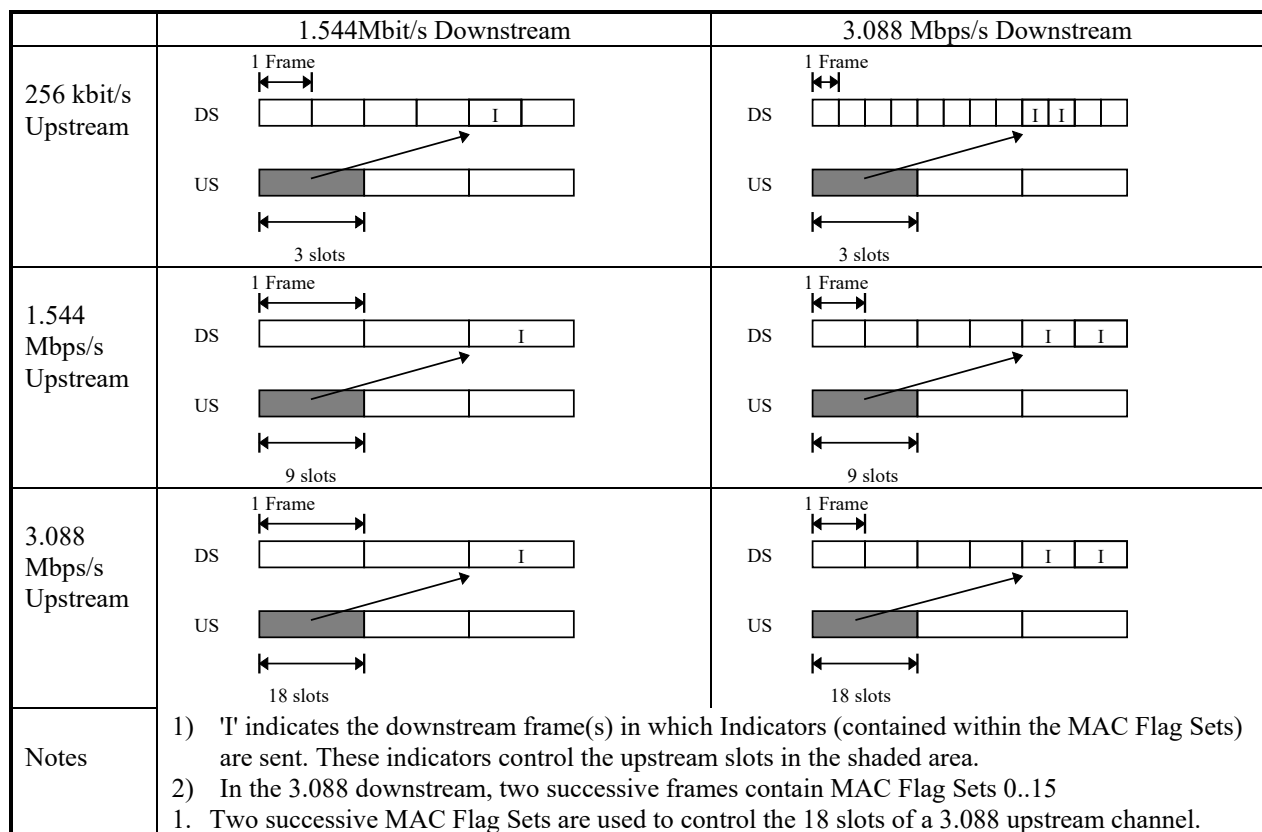

Figure 2-11 Relationship of US Slot to DS Indicator

Reservation Control (b16-b17) - When the reservation control field has the value of 0, no reservation attempts are allowed to be transmitted on the corresponding QPSK upstream channel during the slot positions associated with the next 3 msec period. When the reservation

control field has the value of 1, reservation attempts can be made. The values 2 and 3 are reserved.

CRC 6 Parity (b18-b23) - This field contains a CRC 6 parity value calculated over the previous 18 bits. The CRC 6 parity value is described in the SL-ESF frame format Section.

In the case where there is more than one OOB DS QPSK channel related to an upstream QPSK channel, the SL-ESF overhead bits and the payload R-bytes shall be identical in those OOB DS channels, with the exception of the overhead CRC (C1-C6) bits, which are specific to each of those OOB DS channels. Such related DS channels shall be synchronized.

The MAC messages that are required to perform the MAC functions for the upstream channel shall be transmitted on each of its related OOB DS channels.

2.1.11 ATM Cell Structure

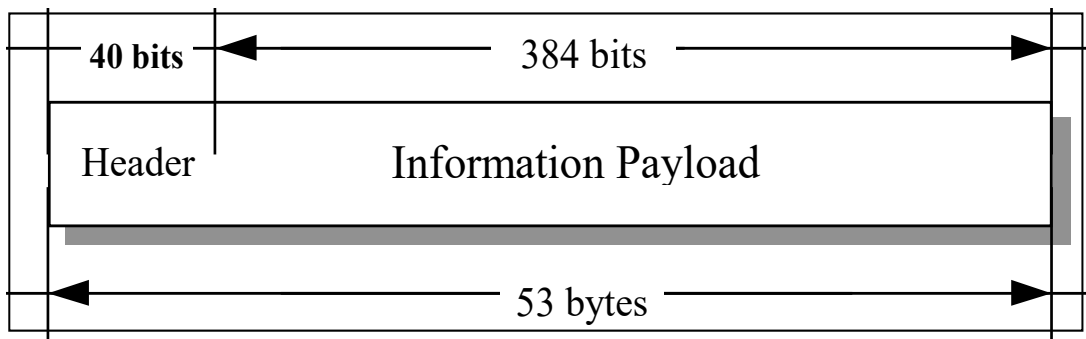

Figure 2-12 ATM Cell Structure

The format for each ATM cell structure is illustrated in Figure 2-12 . This structure and field coding shall be consistent with the structure and coding given in [ITU-T I.361 [Ref. 2] for ATM UNI, both for the ATM and non-ATM based passband bi-directional PHY on coax.

2.2 Upstream Physical Interface Specification

To carry upstream information a combination of quaternary phase shift keying (QPSK) and a Time Division Multiplexing structure are specified. QPSK is specified due to its increased error performance, its spectral efficiency, and its ability to be transmitted at higher than average power levels. DAVIC specified Grade B is mandatory with Grades A and C being optional.

2.2.1 Quaternary Phase Shift Keying (QPSK)

An overview of QPSK modulation has been provided in the downstream QPSK modulation section.

The QPSK signal parameters are:

$$\text{RF bandwidth} \quad \text{BW} = (f_b / 2) * (1 + \alpha)$$

$$\text{Occupied RF Spectrum } [f_c - \text{BW}/2, f_c + \text{BW}/2]$$

$$\text{Symbol Rate} \quad f_s = f_b / 2$$

$$\text{Nyquist Frequency} \quad f_N = f_s / 2$$

with f_b = bit rate, f_c = carrier frequency and α = excess bandwidth.

For all three bit rates: 256 kbit/s (Grade A), 1.544 Mbps/s (Grade B) and 3.088 Mbps/s (Grade C), the Power Spectrum at the QPSK transmitter shall comply to the Power Spectrum Mask given in Table 2-4 and **Figure 2-13**. The Power Spectrum Mask shall be applied symmetrically around the carrier frequency.

Table 2-4 QPSK Upstream Transmitter Power Spectrum

$ (f - f_c) / f_N $	Power Spectrum
$\leq 1 - \alpha$	0 ± 0.25 dB
at 1	-3 ± 0.25 dB
at $1 + \alpha$	≤ -21 dB
≥ 2	≤ -40 dB

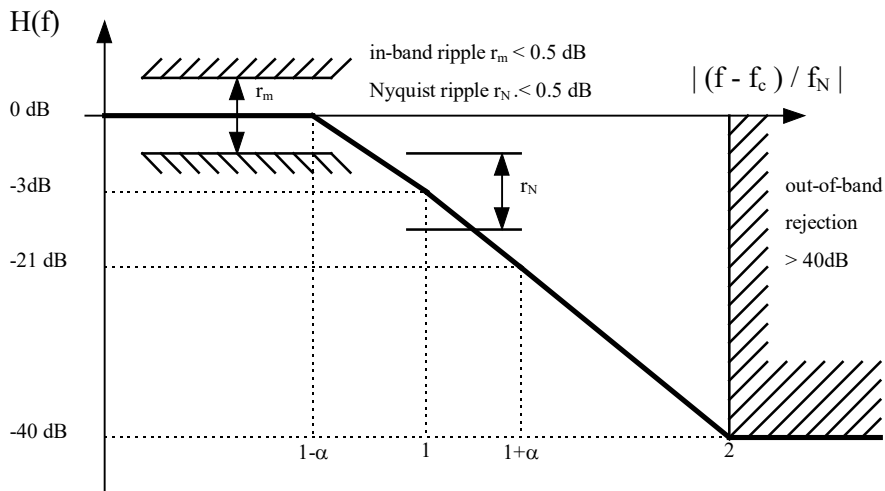

Figure 2-13 QPSK Upstream Transmitter Power Spectrum

The specifications which shall apply to QPSK modulation for the upstream channel are given in Table 2-5.

Table 2-5 Specifications for QPSK Modulation (Upstream)

Specifications for QPSK Modulation (Upstream)									
Transmission Rate	Three grades of modulation transmission rate are specified: <table border="1"> <thead> <tr> <th>Grade</th> <th>Rate</th> </tr> </thead> <tbody> <tr> <td>A</td> <td>256 kbit/s</td> </tr> <tr> <td>B</td> <td>1.544 Mbps/s</td> </tr> <tr> <td>C</td> <td>3.088 Mbps/s</td> </tr> </tbody> </table> <p>A QPSK modulator (transmitter) shall support B grade of transmission with A and C grades of transmission being optional. A QPSK demodulator (receiver) shall support B grade with A and C being optional.</p>	Grade	Rate	A	256 kbit/s	B	1.544 Mbps/s	C	3.088 Mbps/s
Grade	Rate								
A	256 kbit/s								
B	1.544 Mbps/s								
C	3.088 Mbps/s								
Modulation	Differentially encoded QPSK								
Transmit Filtering	$\alpha = 0.30$ square root raised cosine for Grade A (256 kbit/s), Grade B (1.544 Mbps/s), and Grade C (3.088 Mbps/s)								
Channel Spacing	200 kHz for Grade A (256 kbit/s) 1 MHz for Grade B (1.544 Mbps/s) 2 MHz for Grade C (3.088 Mbps/s)								
Frequency Step Size	50 kHz for Grade A, Grade B, and Grade C								
Unique Word	The unique word is four bytes: CC CC CC 0D hex, transmitted in this order.								

Specifications for QPSK Modulation (Upstream)

Randomization

The unique word shall be sent in the clear. After addition of the FEC bytes, randomization shall apply only to the 53-byte payload area and 6 FEC bytes, with the randomizer performing modulo-2 addition of the data with a pseudo-random sequence. The generating polynomial is $x^6 + x^5 + 1$ with seed all ones. Byte/serial conversion shall be MSB first. The 472-bit binary sequence generated by the shift register starts with 00000100... The first "0" is to be added to the first bit after the unique word.

Randomizer:

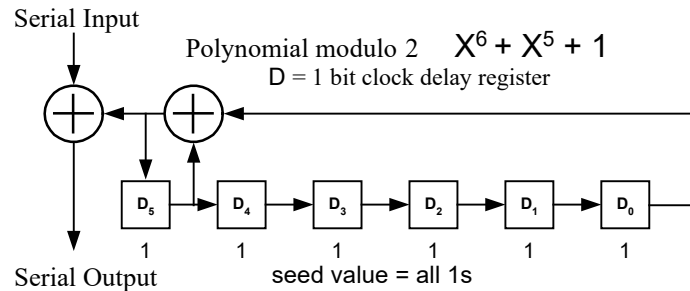

A complementary non self-synchronizing derandomizer is used in the receiver to recover the data. The derandomizer shall be enabled after detection of the unique word.

Derandomizer:

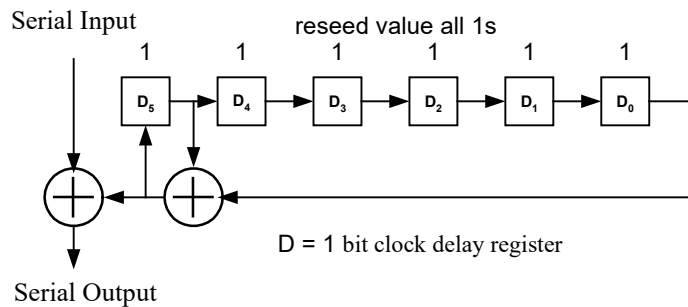

Differential Encoding

Bytes entering the byte-to-symbol encoder are divided into four bit pairs, each bit pair generating one QPSK symbol. Byte boundaries coincide with bit pair boundaries: that is, no bit pairs overlap two bytes. The bit pair corresponding to the MSBs of the byte is sent first. Within each bit pair, the more significant bit is referred to a 'A' and the less significant as 'B'. The differential encoder shall accept bits (A,B) in sequence, and generate phase changes as follows:

<u>A</u>	<u>B</u>	<u>Phase Change</u>
0	0	none
0	1	+ 90 degrees
1	1	180 degrees
1	0	- 90 degrees

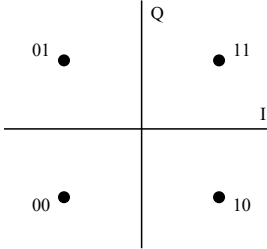
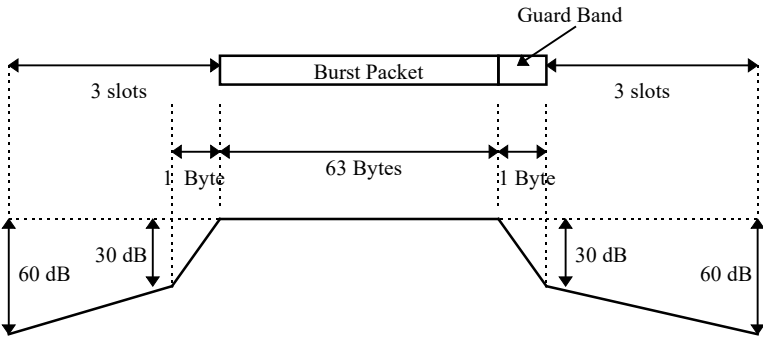
Specifications for QPSK Modulation (Upstream)	
Signal Constellation	<p>The outputs I, Q from the differential encoder map to the phase states as follows:</p>  <p>This constellation is used for the detection of the Unique Word, which is not differentially encoded.</p>
Carrier Center Frequency Range	8 - 26.5 MHz. The transmitter shall operate over the entire specified frequency range. The lowest carrier center frequency is 8 MHz.
Frequency Stability	+/- 50 ppm measured at the upper limit of the frequency range
Symbol Rate Accuracy	+/- 50 ppm
Transmitter Power Spectrum Mask	A common mask for all three bit rates: 256 kbit/s (Grade A), 1.544 Mbps/s (Grade B) and 3.088 Mbps/s (Grade C) is given in Table 2-4.
Carrier Suppression when Transmitter Active	> 30 dB
Carrier Suppression when Transmitter Idle	<p>The Carrier Suppression shall be more than 60 dB below nominal power output level, over the entire power output range and 30 dB right after or before transmission. Details are shown in the figure below.</p> <p>NOTE: Idle Transmitter Definition: A terminal is considered to be idle if it is 3 slots before an imminent transmission or 3 slots after its most recent transmission.</p> 
I/Q Amplitude Imbalance	< 1.0 dB
I/Q Phase Imbalance	< 2.0 degree
Transmit Power Level at the modulator output (upstream)	85 - 113 dBmicroV (RMS) (75 Ohm)
C/N at the demodulator input at the A3 reference point (Nyquist bandwidth, white noise)	<p>≥ 20 dB @ 1x10E-6 packet loss (after error correction)</p> <p>NOTE: A packet loss occurs when one or more bit per packet (after error correction) are uncorrectable.</p>

2.2.2 Coaxial Cable Impedance

The coaxial cable nominal impedance shall be 75 Ohm over the frequency range as specified, see .

2.2.3 Time Division Multiple Access (TDMA)

TDMA allows a DAVIC DHCT access onto a signaling channel for upstream Application control information. The TDMA technique is used for communication between the DHCT and the Service Provider System. TDMA is based on dividing access by multiple set-top units onto a shared signaling channel. This technique provides a negotiated bandwidth allocation slot access method.

2.2.3.1 Slot Definition

The TDMA technique utilizes a slotting methodology which allows the transmit start times to be synchronized to a common clock source. Synchronizing the start times increases message throughput of this signaling channel since the message packets do not overlap during transmission. The period between sequential start times are identified as slots. Each slot is a point in time when a message packet can be transmitted over the signaling link.

The time reference for slot location is received via the downstream channels generated at the Delivery System and received simultaneously by all set-top units. Since all DHCTs reference the same time base, the slot times are aligned for all DHCTs. However, since there is propagation delay in any transmission network, a time base ranging method accommodates deviation of transmission due to propagation delay.

The upstream slot rates are 3000 upstream slots/sec when the upstream data rate is 1.544 Mbps/s and 500 upstream slots/sec when the upstream data rate is 256 kbit/s.

The format of the upstream slot is shown in Figure 2-14. A Unique Word (UW) (4 bytes) provides a burst mode acquisition method. The payload area (53 bytes) contains a single message cell as described previously. The RS Parity field (6 bytes) provides $t=3$ Reed Solomon protection RS(59,53) over the payload area. The Guard band (1 byte) provides spacing between adjacent packets.

Reed-Solomon encoding shall be performed on each ATM cell with $T=3$. This means that 3 erroneous byte per ATM cell can be corrected. This process adds 6 parity bytes to the ATM cell to give a codeword of (59,53). Reed-Solomon encoding is performed on the ATM cell before upstream data randomization.

The Reed-Solomon code shall have the following generator polynomials:

Code Generator Polynomial: $g(x) = (x + \mu^0)(x + \mu^1)(x + \mu^2) \dots (x + \mu^5),$

where $\mu=02\text{hex}$

Field Generator Polynomial: $p(x) = x^8 + x^4 + x^3 + x^2 + 1$

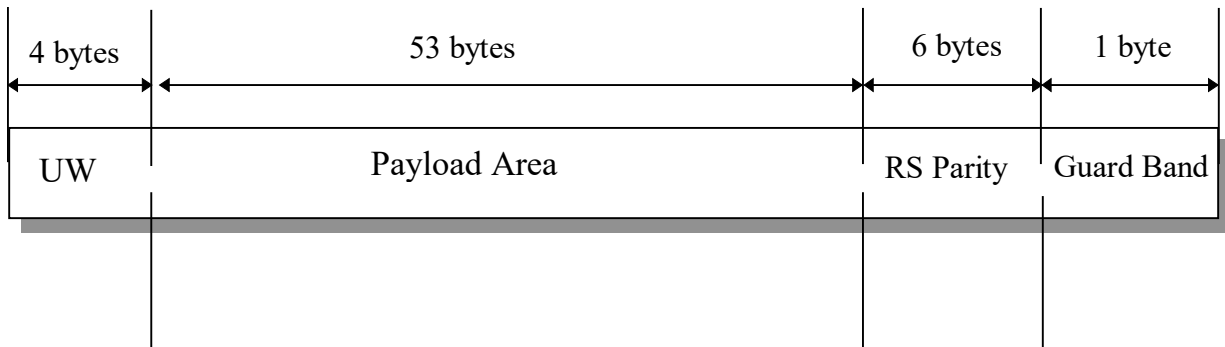

Figure 2-14 Upstream Slot Structure

This structure and field coding shall be consistent with the structure and coding given in [ITU-T I.361] [Ref. 2] for ATM UNI.

2.2.3.2 Slot Definition Assignment

Since the TDMA signaling link is used by DHCTs that are engaged in interactive sessions, the number of available message slots on this channel is dependent on the number of simultaneous users. When messaging slots are not in use, an DHCT may be assigned multiple message slots for increased messaging throughput. Additional slot assignments are provided to the DHCT from the downstream signaling information flow.

2.2.4 Contention Based Access

Upstream session related control information and network related control information are provided via a service channel using quaternary phase shift keying (QPSK) along with a contention-based protocol.

Contention based access is used for managing contention of transmission over a signaling link. For the DAVIC system, this protocol is utilized as a technique for signaling between an DHCT and the Delivery System's Service-Related Control function. Contention based access provides instant channel allocation for the DHCT.

The Contention based technique is used for multiple subscribers that will have equal access to the signaling channel. It is probable that simultaneous transmissions will occur. The Contention based technique provides resolution of signaling throughput when simultaneous transmissions occur.

2.2.4.1 Slot Definition

The slot definition utilized for the contention based access is the same as that defined in the TDMA section, 2.2.3.1.

2.2.4.2 Positive Acknowledgment

For each ATM cell transmitted by the DHCT, a positive acknowledgment is sent back by the NMS, utilizing the reception indicator field, for each successfully received ATM cell. In

contention based access mode, a positive acknowledgment indicates that a collision did not occur. A collision occurs if two or more DHCTs attempt ATM cell transmission during the same slot. A collision will be assumed if a DHCT does not receive a positive acknowledgment. If a collision occurs, then the DHCT will initiate a retransmission procedure.

2.2.5 Relationship between Downstream MAC Control Channels and Upstream Channels

Up to 8 QPSK Upstream channels can be related to each downstream channel which is designated as a MAC control channel. This relationship consists of the following items:

- (1) Each of these related upstream channels share a common slot position. This reference is based on 1 millisecond time markers that are derived via information transmitted via the downstream MAC control channel.
- (2) Each of these related upstream channels derive slot numbers from information provided in the downstream MAC control channel.
- (3) The Messaging needed perform MAC functions for each of these related upstream channels is transmitted via the downstream MAC control channel.

2.2.6 Slot Location and Alignment for the QPSK Upstream Channels

Transmission on each QPSK upstream channel is based on dividing access by multiple DHCTs by utilizing a negotiated bandwidth allocation slot access method. A slotting methodology allows the transmit slot locations to be synchronized to a common slot position reference, which is provided via the related downstream MAC control channel. Synchronizing the slot locations increases message throughput of the upstream channels since the ATM cells do not overlap during transmission.

The slot position reference for upstream slot locations is received via the related downstream MAC control channel by each DHCT. Since each DHCT receives the downstream slot position reference at a slightly different time, due to propagation delay in the transmission network, slot position ranging is required to align the actual slot locations for each related upstream channel. The upstream slot rates are 3000 upstream slots/sec when the upstream data rate is 1.544 Mbps/s and 500 upstream slots/sec when the upstream data rate is 256 kbit/s.

The number of slots available in any one second is given by

$$\text{number of slots/sec} = (\text{upstream data rate} / 512) + \text{extra guardband}$$

where extra guardband may be designated between groups of slots for alignment purposes.

2.2.6.1 Upstream Data Rate - 1.544 Mbps/s

In the case where the upstream data rate is 1.544 Mbps/s, the upstream slots are numbered as shown below, where k is a multiple of 9.

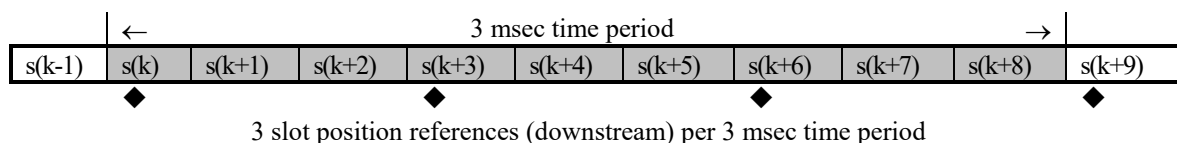

The relationship between the received slot position reference and the actual slot transmit position is given by:

$$\text{slot_transmit_position} = \text{slot_position_reference} + \text{slot_position_offset}$$

where slot_position_offset is derived from the Time_Offset_Value provided via the Range_and_Power_Calibration_Message.

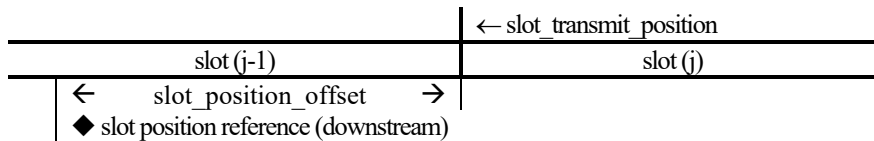

In the case where the upstream data rate is 1.544 Mbps/s, the actual slot transmission locations are given by

$$\text{slot_transmission_location} (m) = \text{slot_transmission_position} + (m * 512);$$

where m = 0,1,2; is the position of the slot with respect to the slot_transmission_position

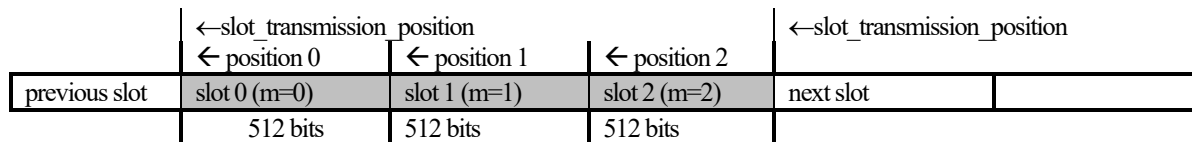

2.2.6.2 Upstream Data Rate - 256 kbit/s

In the case where the upstream data rate is 256 kbit/s, the upstream slots are numbered as shown below, where k is a multiple of 3.:

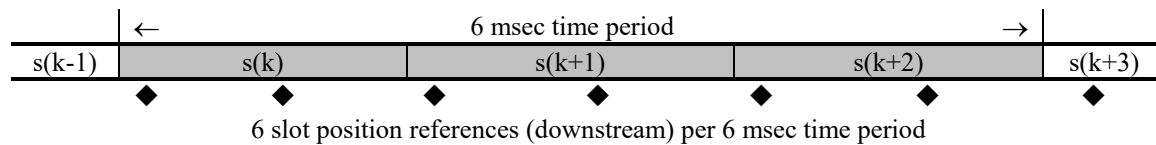

The relationship between the received slot position reference and the actual slot transmit position is given by:

slot_transmit_position = slot_position_reference (integer) + slot_position_offset where only the slot_position_references corresponding to integer values are valid and the slot_position_offset is derived from the Time_Offset_Value provided via the Range_and_Power_Calibration_Message.

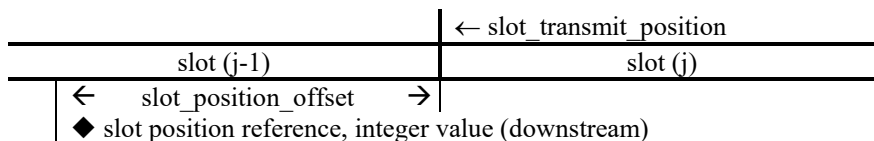

In the case where the upstream data rate is 256 kbit/s, the actual slot transmission locations correspond directly to the integer valued slot position references.

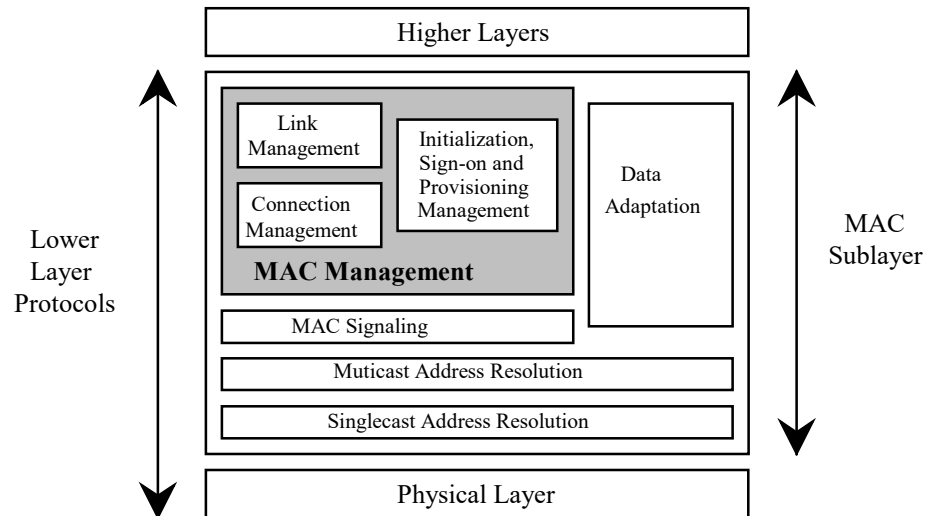

Figure 2-15 MAC Reference Model

This section focuses on the required message flows between the NMS and the DHCT for Media Access Control. These areas are divided into three categories: Initialization, Provisioning and Sign On Management, Connection Management and Link Management.

2.3.2 Upstream and Downstream Channel Types

This section defines the upstream and downstream channel types supported by the Media Access Control Protocol.

2.3.2.1 Downstream Out of Band Channel Requirements

The Media Access Control Protocol supports multiple downstream Channels. In instances where multiple Channels are used, the NMS shall specify a single Out of Band frequency where DHCTs perform Initialization, Provisioning and Sign On Functions. In instances where only a single frequency is in use, the NMS shall utilize that frequency for Initialization, Provisioning and Sign On functions.

2.3.2.2 Upstream Channel Requirements

The Media Access Control protocol supports multiple upstream channels. One of the upstream channels shall be designated the Service Channel. The Service Channel shall be used by DHCTs entering the network via the Initialization, Provisioning and Sign-On procedure. The remaining upstream channels shall be used for upstream data transmission. In cases where only one upstream channel is utilized, the functions of the Service Channel shall reside in conjunction with regular upstream data transmission.

2.3.3 MAC Information Transport

To support the delivery of MAC related information to and from the DHCT, a dedicated Virtual Channel shall be utilized. The VPI,VCI for this channel shall be 0x000,0x0021.

AAL5 (as specified in [ITU-T I.363.5] [Ref. 3]) adaptation shall be used to encapsulate each MAC SDU in ATM cells. All upstream MAC messages shall be restricted to a single cell. A single cell MAC SDU can accommodate up to 40 bytes.

Since MAC related information is terminated at the DHCT and NMS a privately defined message structure will be utilized. The format of the MAC message structure is illustrated below.

Note: All messages are sent most significant bit first.

MAC_message(){	Bits	Bytes	Bit Number / Description
Message_Configuration		1	
Protocol_Version	5		7..3:{enum}
Syntax_Indicator	3		2..0:{enum}
Message_Type	8	1	
if (Syntax_Indicator==001) {			
MAC_Address	48	6	
}			
MAC_Information_Elements ()		N	
}			
}			

Protocol Version

Protocol_Version is a 5 bit enumerated type used to identify the current MAC version.

enum Protocol_Version	{	DAVIC 1.0 Compliant Device, SCTE OOB Transport mode B, Reserved 2..31	};
-----------------------	---	---	----

Syntax Indicator

Syntax_Indicator is a 3-bit enumerated type that indicates the addressing type contained in the MAC message.

enum Syntax_Indicator	{	No_MAC_Address, MAC_Address_Included, Reserved 2..7	};
-----------------------	---	---	----

MAC Address

MAC_Address is a 48-bit value representing the unique MAC address of the DHCT.

2.3.4 MAC Message Types

All MAC message types are listed in Table 2-6. The MAC message types are divided into the logical MAC states of Initialization, Sign On, Connection Management and Link Management. Messages in *Italic* represent upstream transmission from DHCT to NMS. MAC messages are sent using Broadcast or Singlecast Addressing. Singlecast address shall utilize the 48 bit MAC address.

Table 2-6 DAVIC MAC Messages

Message Type Value	Message Name	Addressing Type
0x01-0x1F	MAC Initialization, Provisioning and Sign-On Message	
0x01	Provisioning Channel Message	Broadcast
0x02	Default Configuration Message	Broadcast
0x03	Sign-On Request Message	Broadcast
0x04	<i>Sign-On Response Message</i>	Singlecast
0x05	Ranging and Power Calibration Message	Singlecast
0x06	<i>Ranging and Power Calibration Response Message</i>	Singlecast
0x07	Initialization Complete Message	Singlecast
0x08-0x1F	[Reserved]	
0x20-0x3F	MAC Connection Establishment and Termination Msgs	
0x20	Connect Message	Singlecast
0x21	<i>Connect Response Message</i>	Singlecast
0x22	<i>Reservation Request Message</i>	Singlecast
0x23	Reservation Response Message	Broadcast
0x24	Connect Confirm Message	Singlecast
0x25	Release Message	Singlecast
0x26	<i>Release Response Message</i>	Singlecast
0x27	<i>Idle Message</i>	Singlecast
0x28	Reservation Grant Message	Broadcast
0x29	Reservation ID Assignment	Singlecast
0x2A	<i>Reservation Status Request</i>	Singlecast
0x2B	<i>Reservation ID Response Message</i>	Singlecast
0x2C-0x3F	Reserved]	
0x40-0x5F	MAC Link Management Msgs	
0x40	Transmission Control Message	Singlecast
0x41	Reprovision Message	Singlecast
0x42	<i>Link Management Response Message</i>	Singlecast
0x43	Status Request Message	Singlecast
0x44	<i>Status Response Message</i>	Singlecast
0x45-0x5F	[Reserved]	

2.3.4.1 MAC Initialization, Provisioning and Sign On

This section defines the procedure for Initialization, Provisioning and Sign On that the MAC shall perform during power on or Reset.

2.3.4.1.1 Initialization and Provisioning

1. Upon a DHCT becoming active (i.e. powered up), it must first find the current provisioning frequency. The DHCT shall receive the **<MAC> Provisioning Channel Message**. This message shall be sent aperiodically on all downstream OOB channels when there are multiple channels. In the case of only a single channel, the message shall indicate the current channel is to be utilized for Provisioning. Upon receiving this message, the DHCT shall tune to the Provisioning Channel.
2. After a valid lock indication on a Provisioning Channel, the DHCT shall await the **<MAC> DEFAULT CONFIGURATION MESSAGE**. When received, the DHCT shall configure its parameters as defined in the default configuration message. The Default Configuration Parameters shall include default timer values, default power levels, default retry counts as well as other information related to the operation of the MAC protocol.

Figure 2-16 below shows the signaling sequence.

Figure 2-16 Initialization and Provisioning Sequence

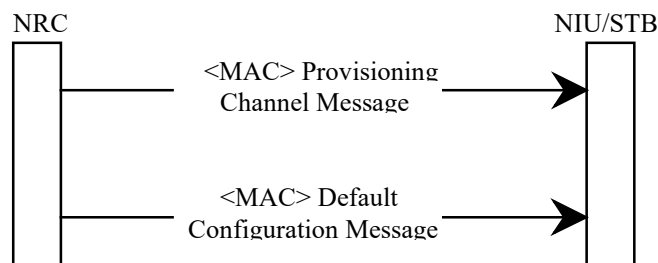

2.3.4.1.2 Sign On and Calibration

The DHCT shall Sign On via the Sign-On Procedure. A state diagram for Ranging and Calibration is given in Figure 2-18. The signaling flow for Sign-On is shown in Figure 2-17 and described below. Reception Indicators shall be ignored during the Sign-On and Calibration process.

1. The DHCT shall tune to the downstream Provisioning channel and the upstream service channel with the information provided in the Initialization and Provisioning sequence.
2. The DHCT shall await the **<MAC> Sign-On Request Message** from the Network Related Control Entity. The DHCT shall utilize Contention based entry on the service channel to access the network.
3. Upon receiving the **<MAC> Sign-On Request Message**, the DHCT shall respond with the **<MAC> Sign-On Response Message**. The Sign-On Response Message shall be transmitted on a Ranging Control Slot.
4. The NMS, upon receiving the Sign-On Response Message shall validate the DHCT and send the **<MAC> Ranging and Power Calibration Message**.

5. The DHCT shall respond to the <MAC> Ranging and Power Calibration Message with the <MAC> Ranging and Power Calibration Response Message. The <MAC> Ranging and Power Calibration Response Message shall be transmitted on a Ranging Control Slot.
6. The NMS shall send the <MAC> **Initialization Complete Message** when the DHCT is calibrated. The DHCT is assumed to be calibrated if the message arrives within a window of 1.5 symbols (upstream rate) and a power within a window of 1.5 dB from their optimal value.

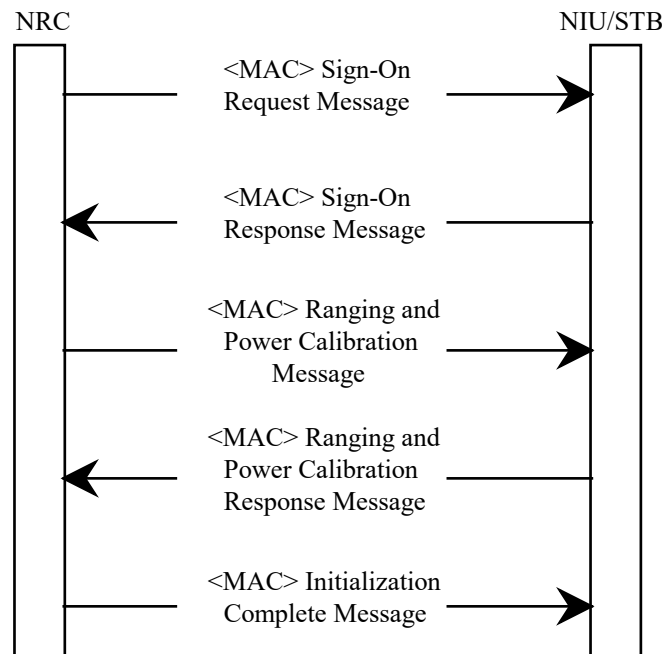
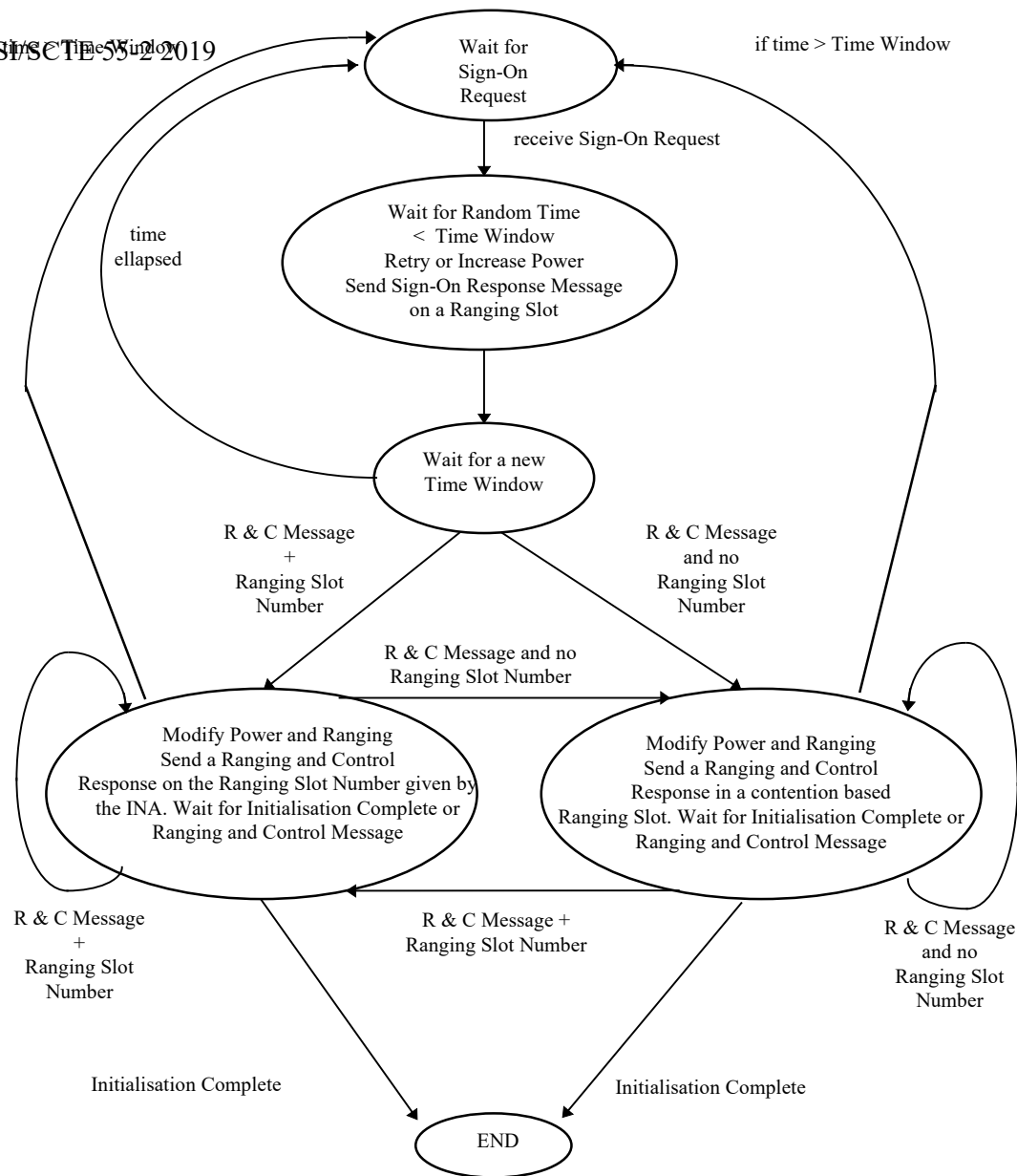

Figure 2-17 Sign-On Messaging Sequence

Figure 2-18 State Diagram for Ranging and Calibration



2.3.4.2 Connection Management

This section defines the MAC support for Connection Establishment and Release.

2.3.4.2.1 Connection Establishment

Once a DHCT has completed the Calibration State, it shall enter the Connection State. A low bit rate permanent connection can be assigned to a DHCT by the NMS. The NMS can assign an upstream channel for contention or contentionless based access to the network. In either case after the initial calibration procedure, the NMS provides a Default Connection to the DHCT that the DHCT shall utilize to communicate to the network. A given connection (identified by a Connection_ID) shall be assigned, at most, a single VPI/VCI. The message flow for such Connection Establishment is shown in Figure 2-19 .

For all the traffic sent contention access, a collision is assumed if the appropriate reception indicator of the slot used for transmission is not set. A counter at the DHCT records the number, denoted by `backoff_exponent`, of collisions encountered by a cell. The `backoff_exponent` counter starts from a value determined by the `Min_Backoff_Exponent` variable. The `backoff_exponent` is used to generate a uniform random number between 1 and $2^{\text{backoff_exponent}}$. This random number is used to schedule retransmission of the collided cell. In particular, the random number indicates the number of contention access slots the DHCT shall wait before it transmits. The first transmission is carried out in a random cell within the contention based access region. If the counter reaches the maximum number, determined by the `Max_Backoff_Exponent` variable, the value of the counter remains at this value regardless of the number of subsequent collisions. After a successful transmission the `backoff_exponent` counter is reset to a value determined by the `Min_Backoff_Exponent` variable.

In addition to the simple connect and release messages used to establish and remove connections, the MAC message set provides two additional messages to handle dynamic reallocation of bandwidth and channels. The Transmission Control Message and the Reprovision Message provide the ability to redefine the parameters of each connection individually or as group.

The existing messages allow reallocation of resources on the network for an individual DHCT. For example, the existing connections for a single DHCT may be removed, the channel changed, and new connections reestablished to the existing sessions. The Reprovision Message allows for modification of the current connection parameters including channel assignment. Gross reallocation of bandwidth or channels is provided by moving all connections from one channel to another channel at once. The Transmission Control Message provides a method to rapidly change the channel frequencies and other associated parameters for a single DHCT or all DHCTs assigned to a given channel.

1. After Initialization, Provisioning and Sign On Procedures are complete, the NMS shall assign a default upstream and downstream connection to the DHCT. This connection can be assigned on any of the upstream channels except the upstream service channel ranging area. The DHCT shall assign the default connection by sending the `<MAC> Connect Message` to the DHCT. This message shall contain the upstream connection parameters and downstream frequency on which the default connection is to reside.

2. The DHCT, upon receiving the **<MAC> Connect Message** shall tune to the required upstream and downstream frequencies and send the **<MAC> Connect Response Message** confirming receipt of the message.
1. Upon receipt of the **<MAC> Connect Message**, the NMS shall confirm the new connection to proceed by sending the **<MAC> Connect Confirm Message**.

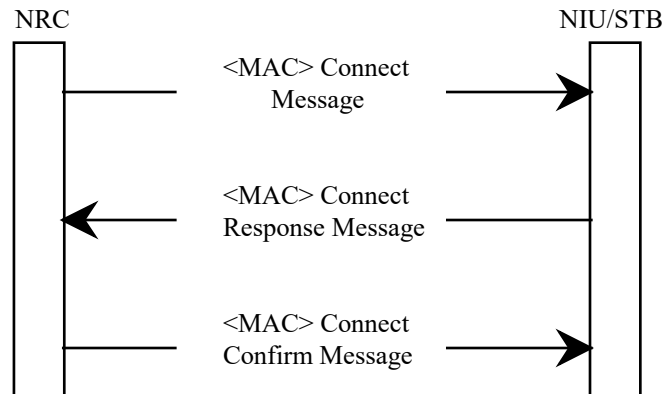

Figure 2-19 Connection Establishment Signaling Sequence

Different access modes are provided to the DHCT within access regions specified by information contained in the slot boundary fields of the downstream superframes. The limits between access regions allow users to know when to send data on contention without risks of collision with contentionless type data. The following rules define how to select access modes:

- Data connections:

When the NMS assigns a connection ID to the DHCT, it either specifies a slot list to be used (Contentionless access) or the DHCT shall use contention or reserved access by following this algorithm:

When the DHCT must send more cells than what was assigned by the NMS, it can use contention access only if the number of cells to transmit is less than `Maximum_contention_access_message_length` (specified in the MAC Connect Message from the NMS). In that case, it must wait for the slot reception indicator before it is allowed to send other cells with the same VPI/VCI value. The DHCT can send one request for reservation access if the number of cells is less than `Maximum_reservation_access_message_length` (specified in the MAC Connect Message from the NMS). If more cells must be transmitted, the DHCT must send multiple requests for reservation access.

- MAC messages:

MAC messages can be sent on contention access or reservation access. MAC messages sent upstream must be less than 40 bytes long. If the MAC information exceeds 40 bytes, it must be segmented into multiple 40 bytes independent MAC messages. Ranging access can only be used for specific MAC messages.

The following Upstream Access Types are defined:

- Contention Access

Contention Access indicates that data is sent in the slots assigned to the contention access region in the upstream channel. It can be used either to send MAC messages or data. The VPI, VCI of the ATM cells are used to determine the connection, type and direction of the data of higher layers. Contention based access provides instant channel allocation for the DHCT. The Contention based technique is used for multiple subscribers that will have equal access to the channel. Since simultaneous transmissions will occur, a positive acknowledgment of reception by the NMS is sent in the reception indicator field of the OOB downstream channel. A collision will be assumed if an DHCT does not receive a positive acknowledgment.

- Contentionless Access

Contentionless Access indicates that data is sent in slots assigned to the Contentionless based access region in the upstream channel. These slots are uniquely assigned to a connection by the NMS.

- Reservation Access

Reservation Access implies that data is sent in the slots assigned to the reservation region in the upstream channel. These slots are uniquely assigned on a frame by frame basis to a connection by the NMS. This assignment is made at the request of the DHCT for a given connection.

- Ranging Access

Ranging Access indicates that the data is sent in a slot preceded and followed by slots not used by other users. These slots allow users to adjust their clock depending on their distance to the NMS such that their slots fall within the correct allocated time. The Ranging Access area is either in the Contention Access region or in slots assigned to the reservation region in the upstream channel. The reservation slots are uniquely assigned on a frame by frame basis to the DHCT.

2.3.4.2.2 Connection Release

This section defines the MAC signaling requirements for connection release. Figure 2-20 below displays the signaling flow for releasing a connection.

1. Upon receiving the **<MAC> Release Message** from the NMS, the DHCT shall tear down the indicated upstream connections.
1. Upon tear down of the upstream connection, the DHCT shall send the **<MAC> Release Response Message** on the upstream frequency currently being used by the DHCT for MAC Messages.

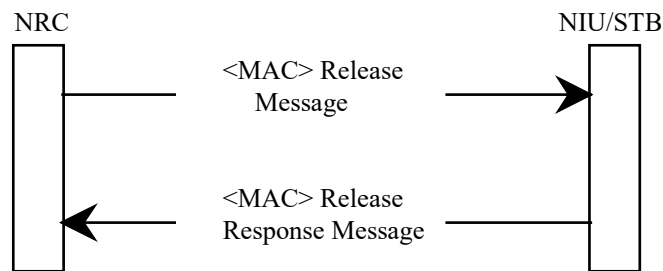

Figure 2-20 Connection Release Signaling

2.3.4.3 MAC Link Management

The MAC Link Management tasks provide continuous monitoring and optimization of upstream resources. These functions include:

- Power and Timing Management
- TDMA Allocation Management
- Reservation Allocation Management
- Channel Error Management

2.3.4.3.1 Power and Timing Management

Power and Timing Management shall provide continuous monitoring of upstream transmission from the DHCT. The **<MAC> Ranging and Power Calibration Message** is used to maintain a DHCT within predefined thresholds of power and time.

The Upstream Burst Demodulator shall continuously monitor the upstream burst transmissions from an DHCT. Upon detection of an DHCT outside the predefined range, the NMS shall send the **<MAC> Ranging and Power Calibration Message** to the DHCT.

2.3.4.3.2 TDMA Allocation Management

To ensure optimum assignment of TDMA resources, the NMS shall ensure the upstream allocation of TDMA resources for various connections remain intact when allocating resources to a new connection. However, in the event that reconfiguration is required to minimize fragmentation of resources, then the NMS shall dynamically reconfigure the upstream TDMA assignments to a DHCT or group of DHCT. The **<MAC> Reprovision Message** is utilized to change previously established connection parameters.

2.3.4.3.3 Channel Error Management

During periods of connection inactivity, the DHCT shall enter an Idle Mode. Idle mode is characterized by periodic transmission by the DHCT of a **<MAC> Idle Message**. The Idle

Mode transmission shall occur at a periodic rate sufficient for the NMS to establish Packet Error Rate statistics.

2.3.4.4 MAC Message Definitions

For all MAC messages where the parameter length is smaller than the field, the parameter shall be right justified with leading bits set to 0.

All reserved fields in the MAC messages shall be set to 0.

2.3.4.4.1 Initialization, Provisioning and Sign On Messages

This section provides a detailed definition of the MAC messages for Initialization, Provisioning and Sign-On procedures.

2.3.4.4.1.1 <MAC> Provisioning Channel Message

The <MAC> PROVISIONING CHANNEL MESSAGE is sent by the NMS to direct the DHCT to the proper Out of Band frequency where provisioning is performed. The format of the message is shown below.

Provisioning_Channel_Message(){	Bits	Bytes	Bit Number / Description
Provisioning_Channel_Control_Field		1	
Reserved	7		7..1
Provisioning_Frequency_Included	1		0: {no, yes}
if (Provisioning_Channel_Control_Field == Provisioning_Frequency_Included) {			
Provisioning_Frequency	32	4	
Downstream_Type	8	1	{enum}
}			
}			

Provisioning Channel Control Field

Provisioning_Channel_Control_Field is used to specify the downstream frequency where the DHCT will be provisioned.

Provisioning Frequency Included

Provisioning_Frequency_Included is a Boolean when set, indicates that a downstream OOB frequency is specified that the DHCT should tune to begin the provisioning process. When cleared, indicates that the current downstream frequency is the provisioning frequency.

Provisioning Frequency

Provisioning_Frequency is a 32-bit unsigned integer representing the Out of Band Frequency in which DHCT provisioning occurs. The unit of measure is Hz.

Downstream Type

Downstream_Type is an 8-bit enumerated type indicating the modulation format for the downstream connection.

enum	Downstream_Type	{	Reserved, QPSK_1.544, QPSK_3.088, Reserved 3..255	};
------	-----------------	---	--	----

2.3.4.4.1.2 <MAC> Default Configuration Message

The <MAC> DEFAULT CONFIGURATION MESSAGE is sent by the NMS to the DHCT. The message provides default parameter and configuration information to the DHCT. The format of the message is shown below

Default_Configuration_Message(){	Bits	Bytes	Bit Number / Description
Regs_Incr_Pwr_Retry_Count	8	1	
Service_Channel_Frequency	32	4	
Service_Channel_Control_Field		1	
MAC_Flag_Set	5		7..3
Service_Channel	3		2..0
Backup_Service_Channel_Frequency	32	4	
Backup_Service_Channel_Control_Field		1	
Backup_MAC_Flag_Set	5		7..3
Backup_Service_Channel	3		2..0
Service_Channel_Frame_Length	16	2	
Service_Channel_Last_Slot	13	2	
Max_Power_Level	8	1	
Min_Power_Level	8	1	
Upstream_Transmission_Rate	3	1	{enum}
Max_Backoff_Exponent	8	1	
Min_Backoff_Exponent	8	1	
Idle_Interval	16	2	
}			

Sign-On Increment Power Retry Count

Regs_Incr_Pwr_Retry_Count is an 8-bit unsigned integer representing the number of attempts the DHCT should try to enter the system at the same power level before incrementing its power level.

Service Channel Frequency

Service_Channel_Frequency is a 32 bit unsigned integer representing the upstream frequency assigned to the service channel. The unit of measure is in Hz.

MAC_Flag_Set

MAC_Flag_Set is a 5 bit field indicating the MAC Flag set number assigned to the service channel (i.e. R1a, R1b and R1c represent MAC Flag set 1). It can take the values 1..16. Values 0 and 17..31 are invalid.

A downstream channel contains control information for each of its associated upstream channels. This information is contained within structures known as MAC Flags. A set of MAC

Flags, represented by either 24 bits (denoted b0..b23) or by 3 bytes (denoted Rxa, Rxb and Rxc), are uniquely assigned to a given upstream channel. Refer to section 2.1.9 for a definition of the MAC Flags.

In the OOB downstream case, each SL-ESF frame structure contains eight sets of MAC Flags represented by Rxa, Rxb and Rxc, where x is replaced by the numbers 1..8. In the case of a 1.544 Mbit/s downstream bit rate, only one SL-ESF frame occurs during a 3 ms interval providing 8 sets of MAC Flags. In the case of a 3.088 Mbit/s downstream bit rate, two SL-ESF frames occur during a 3 ms interval, providing 16 sets of MAC Flags. The second set of MAC Flags (contained in the second SL-ESF) are denoted by Rxa, Rxb and Rxc, where x is replaced by the numbers 9 through 16.

In case of a 3.088 Mbit/s upstream channel, two sets of MAC Flags are required. In this case, the MAC_Flag_Set parameter represents the first of two successively assigned MAC Flag sets.

Service Channel

Service_Channel is a 3-bit field which defines the channel assigned to the Service_Channel_Frequency. Although the function provided by this parameter is superseded in the DAVIC 1.2 specification by the MAC_Flag_Set, it is retained in order to identify the logical channel assigned to the DHCT.

Backup Service Channel Frequency

Backup_Service_Channel_Frequency is a 32 bit unsigned integer representing the upstream frequency assigned to the backup service channel. The backup service channel is used when entry on the primary service channel fails. The unit of measure is in Hz.

Backup_MAC_Flag_Set

Backup_MAC_Flag_Set is an 5 bit field representing the MAC Flag set assigned to the backup service channel. The function of this field is the same as the MAC_Flag_Set above but with respect to the backup service channel.

Backup_Service_Channel

Backup_Service_Channel is a 3-bit field which defines the channel assigned to the Backup_Service_Channel_Frequency. The function of this field is the same as the Service_Channel above but with respect to the backup channel.

Service Channel Frame Length

Service_Channel_Frame_Length is a 16-bit unsigned integer representing the number of slots in the upstream Contentionless based Service Channel. The unit of measure is slots.

Service Channel Last Slot

Service_Channel_Last_Slot is a 13-bit unsigned integer representing the last slot in the Service Channel.

Maximum Power Level

MAX_Power_Level is a 8-bit unsigned integer representing the maximum power the DHCT shall be allowed to use to transmit upstream. The unit of measure is 0.5dB μ V.

Minimum Power Level

MIN_Power_Level is an 8-bit unsigned integer representing the minimum power the DHCT shall be allowed to use to transmit upstream. The unit of measure is 0.5dB μ V.

Upstream Transmission Rate

Upstream_Transmission_Rate is a 3-bit enumerated type that indicates the upstream transmission rate.

enum Upstream_Transmission_Rate	{	Upstream_256K,
		Upstream_1.544M,
		Upstream_3.088M
		Reserved 3..7
	}	};

MIN_Backoff_Exponent

MIN_Backoff_Exponent is an 8-bit unsigned integer representing the minimum value of the backoff exponent counter.

MAX_Backoff_Exponent

MAX_Backoff_Exponent is an 8-bit unsigned integer representing the minimum value of the backoff exponent counter.

Idle_Interval

Idle_Interval is a 16-bit unsigned integer representing the predefined interval for the MAC Idle Messages. The unit of the measure is in milliseconds.

2.3.4.4.1.3 <MAC> Sign-On Request Message

The <MAC> SIGN-ON REQUEST message is issued periodically by the NMS to allow a DHCT to indicate its presence in the network. The format of this subcommand is shown below. The Sign_On_Request_Message is ignored by the DHCT unless it is in the sign-on mode.

Sign-On_Request_Message(){	Bits	Bytes	Bit Number / Description
Sign-On_Control_Field	8	1	7-1 0 : {no, yes}
Reserved	7		
Address_Filter_Params_Included	1		
Response_Collection_Time_Window	16	2	
if (Sign-On_Control_Field== Address_Filter_Params_Included){			
Address_Position_Mask	(8)	(1)	
Address_Comparison_Value	(8)	(1)	
}			
}			

Sign-On Control Field

Sign-On_Control_Field specifies what parameters are included in the SIGN-ON REQUEST

Address Filter Parameters Included

address_filter_params_included is a Boolean, when set, indicates that the DHCT should respond to the SIGN-ON REQUEST only if its address matches the filter requirements specified in the message.

Response Collection Time Window

Response_Collection_Time_Window is a 16-bit unsigned integer that specifies the duration of time the DHCT has to respond to the SIGN-ON REQUEST. The unit of measure is msec.

Address Position Mask

Address_Position_Mask is an 8-bit unsigned integer that indicates the bit positions in the DHCT MAC address that are used for address filtering comparison. This parameter represents the number of bits that the Address Comparison Value should be left shifted before the compare operation. It has a range from 0 to 40.

Address Comparison Value

Address_Comparison_Value is an 8-bit unsigned integer that specifies the value that the DHCT should use for MAC address comparison. These eight bits are compared against the 8 bits of the MAC address after shifting according to the Address Position Mask.

2.3.4.4.1.4 <MAC> Sign-On Response Message

The <MAC> Sign-On Response Message is sent by the DHCT in response to the <MAC> Sign-On Request Message issued by the NMS Entity.

Sign-On_Response_Message(){	Bits	Bytes	Bit Number / Description
DHCT_Status		4	
Reserved	29		31..3
Network_Address_Registered	1		2:{no, yes}
Default_Connection_Established	1		1:{no, yes}
Calibration_Operation_Complete	1		0:{no, yes}
DHCT_Error_Code		2	
Reserved	13		15..3
Connect_Confirm_Timeout	1		2:{no, yes}
Default_Connection_Timeout	1		1:{no, yes}
Range_Response_Timeout	1		0:{no, yes}
DHCT_Retry_Count	8	1	
}			

DHCT Status

DHCT_Status is a 32-bit field that indicates the current state of the DHCT. It has the following subfields:

Network_Address_Registered indicates that the Network Interface Module has registered its Network Address with the Application Module.

Default_Connection_Established indicates that the Network Interface Module has been assigned Default Connection parameters.

Calibration_Operation_Complete indicates that the Network Interface Module has been successfully calibrated.

DHCT Error Code

DHCT_Error_Code is an 16-bit field that indicates the error condition within the DHCT. It has the following subfields:

Connect_Confirm_Timeout

Default_Connection_Timeout

Range_Response_Timeout

Retry Count

Retry_Count is a 8-bit unsigned integer that indicates the number of transmissions of the <MAC> Sign-On Response Message. This field is always included in the response to the <MAC> Sign-On Request Message.

2.3.4.4.1.5 <MAC> Ranging and Power Calibration Message

The <MAC> RANGING AND POWER CALIBRATION MESSAGE is sent by the NMS to the DHCT to adjust the power level or time offset the DHCT is using for upstream transmission. The format of this message is shown below.

Ranging_and_Power_Calibration_Message(){ Range_Power_Control_Field	Bits	Bytes	Bit Number / Description
Reserved	5	1	7..3
Ranging_Slot_Included	1		2: {no, yes}
Time_Adjustment_Included	1		1: {no, yes}
Power_Adjustment_Included	1		0: {no, yes}
if (Range_Power_Control_Field == Time_Adjustment_Included) { Time_Offset_Value	16	2	
}			
if (Range_Power_Control_Field == Power_Adjustment_Included) { Power_Control_Setting	8	1	
}			
if (Range_Power_Control_Field == Ranging_Slot_Included) { Ranging_Slot_Number	13	2	
}			
}			

Range and Power Control Field

Range_Power_Control_Field specifies which Range and Power Control Parameters are included in the message.

Time Adjustment Included

Time_Adjustment_Included is a Boolean when set, indicates that a relative Time Offset Value is included that the DHCT should use to adjust its upstream Contentionless based transmission.

Power Adjust Included

Power_Adjust_Included is a Boolean when set, indicates that a relative Power Control Setting is included in the message

Ranging Slot Included

Ranging_Slot_Included is a Boolean when set, indicates the calibration slot is included in the message.

Time Offset Value

Time_Offset_Value is a 16-bit short integer representing a relative offset of the upstream transmission timing. A negative value indicates an adjustment forward in time. A positive value indicates an adjustment back in time. The unit of measure is 100 nsec.

Power Control Setting

Power_Control_Setting is an 8-bit signed integer to be used to set the new upstream power level of the DHCT. A positive value represents an increase of the output power level.

$\text{new output_power_level} = \text{current output_power_level} + \text{power_control_setting} * 0.5 \text{ dB}$

Ranging Slot Number

Ranging_Slot_Number is a 13-bit unsigned integer that represents the slot number assigned for ranging the DHCT. It shall be assigned by the NMS in the reservation area. The NCR shall assure that an unassigned slot precedes and follows the ranging slot.

2.3.4.4.1.6 <MAC> Ranging and Power Calibration Response Message

The <MAC> RANGING AND POWER CALIBRATION RESPONSE Message is sent by the DHCT to the NMS in response to the <MAC> RANGING AND POWER CALIBRATION MESSAGE. The format of the message is shown below.

Ranging_Power_Response_Message(){	Bits	Bytes	Bit Number / Description
Power_Control_Setting	8	1	
}			

Power Control Setting

Power_Control_Setting is an 8-bit unsigned integer representing the actual power used by the DHCT for upstream transmission. The unit of measure is 0.5 dB μ V.

2.3.4.4.1.7 Initialization Complete Message

The <MAC> INITIALIZATION COMPLETE Message is sent by the NMS to the DHCT to indicate the end of the MAC Sign-On and Provisioning procedure. The DHCT shall be disabled after receiving a non-zero Completion_Status_Field value.

Initialization_Complete_Message(){	Bits	Bytes	Bit Number / Description
Completion_Status_Field		1	
Reserved	4		7..4
Invalid_DHCT	1		3: {no, yes}
Timing_Ranging_Error	1		2: {no, yes}
Power_Ranging_Error	1		1: {no, yes}
Transmitter_Error	1		0: {no, yes}
}			

Completion_Status_Field

Completion_Status_Field is an 8-bit field that indicates errors in the initialization phase. It has the following subfields:

Invalid_DHCT is a boolean that (when set to 1) indicates that the DHCT is invalid.

Timing_Ranging_Error is a boolean that (when set to 1) indicates that the ranging has not succeeded.

Power_Ranging_Error is a boolean that (when set to 1) indicates that the power ranging has not succeeded.

Transmitter_Error is a boolean that (when set to 1) indicates a transmitter error.

2.3.4.4.2 Connection Management Messages

This section defines the MAC messages for connection establishment and release.

2.3.4.4.2.1 <MAC> Connect Message

Connect_Message (){	Bits	Bytes	Bit Number / Description
Connection_ID	32	4	
Session_Number	32	4	
Resource_Number	16	2	
Connection_Control_Field		1	
DS_ATM_CBD_Included	1		7: {no, yes}
DS_MPEG_CBD_Included	1		6: {no, yes}
US_ATM_CBD_Included	1		5: {no, yes}
Upstream_Channel_Number	3		4..2
Slot_List_Included	1		1: {no, yes}
Cyclic_Assignment	1		0: {no, yes}
Frame_Length	16	2	
Maximum_Contention_Access_Message_Length	8	1	
Maximum_Reservation_Access_Message_Length	8	1	
if (Connection_Control_Field == DS_ATM_CBD_Included) {			
Downstream_ATM_CBD()	64	8	
}			
if (Connection_Control_Field == DS_MPEG_CBD_Included) {			
Downstream_MPEG_CBD()	48	6	
}			
if (Connection_Control_Field == US_ATM_CBD_Included) {			
Upstream_ATM_CBD()	64	8	
}			
if (Connection_Control_Field == Slot_List_Included) {			
Number_Slots_Defined	8	1	
for(i=0; i<Number_Slots_Assigned; i++){			
Slot_Number	13	2	
}			
}			
if (Connection_Control_Field == Cyclic_Assignment) {			
Contentionless_Start	16	2	
Contentionless_Dist	16	2	
Number_Cycle_Slots_Defined	16	2	
}			
}			

Connection ID

Connection_ID is a 32-bit unsigned integer representing a connection Identifier for the DHCT Dynamic Connection.

Session Number

Session_Number is a 32-bit unsigned integer representing the Session that the connection parameters are associated.

Resource Number

Resource_Number is a 16-bit unsigned integer providing a unique number to the resource defined in the message.

Connection Control Field

DS_ATM_CBD_Included is a boolean that indicates that the Downstream ATM Descriptor is included in the message.

DS_MPEG_CBD_Included is a boolean that indicates that the Downstream MPEG Descriptor is included in the message.

US_ATM_CBD_Included is a boolean that indicates that the Upstream ATM Descriptor is included in the message.

Upstream_Channel_Number is a 3-bit unsigned integer that provides an identifier for the upstream channel.

Slot_List_Included is a boolean that indicates that the Slot List is included in the message.

Cyclic_Assignment is a boolean that indicates Cyclic Assignment.

Frame Length

Frame_Length is a 16 bit unsigned number represents the number of successive slots in the contentionless access region that associated with each contentionless slot assignment. In the slot_list method of allocating slots it represents the number of successive slots associated with each element in the list. In the cyclic method of allocating slots it represents the number of successive slots associated with the Contentionless_Start_Slot and those which are multiples of Contentionless_Distance from the Contentionless_Start_Slot.

Maximum Contention Access Message Length

Maximum_Contention_Access_Message_Length is an 8 bit number representing the maximum length of a message in ATM sized cells that may be transmitted using contention access. Any message greater than this should use reservation access.

Maximum Reservation Access Message Length

Maximum_Reservation_Access_Message_Length is an 8 bit number representing the maximum length of a message in ATM sized cells that may be transmitted using a single reservation access. Any message greater than this should be transmitted by making multiple reservation requests.

Downstream ATM Connection Block Descriptor

Downstream_ATM_CBD(){	Bits	Bytes	Bit Number / Description
Downstream_Frequency	32	4	{enum}
Downstream_VPI	8	1	
Downstream_VCI	16	2	
Downstream_Type	8	1	
}			

Downstream_Frequency is a 32-bit unsigned integer representing the Frequency where the connection resides. The unit of measure is in Hz.

Downstream_VPI is an 8-bit unsigned integer representing the ATM Virtual Path Identifier that is used for downstream transmission over the Dynamic Connection.

Downstream_VCI is an 16-bit unsigned integer representing the ATM Virtual Channel Identifier that is used for downstream transmission over the Dynamic Connection.

Downstream_Type is an 8-bit enumerated type indicating the modulation format for the downstream connection.

enum Downstream_Type {	QAM,
	QPSK_1.544,
	QPSK_3.088,
	Reserved 3..255 };

Downstream MPEG Connection Block Descriptor

Downstream_CBD_MPEG(){	Bits	Bytes	Bit Number / Description
Downstream_Frequency	32	4	
Program Number	16	2	
}			

Downstream_Frequency is a 32-bit unsigned integer representing the Frequency where the connection resides. The unit of measure is in Hz.

Program_Number is a 16-bit unsigned integer uniquely referencing the downstream virtual connection assignment.

Upstream ATM Connection Block Descriptor

Upstream_ATM_CBD () {	Bits	Bytes	Bit Number / Description
Upstream_Frequency	32	4	
Upstream_VPI	8	1	
Upstream_VCI	16	2	
Upstream_Parameters		1	
MAC_Flag_Set	5		7..3
Upstream_Rate	3		2..0:{enum}
}			

Upstream_Frequency is a 32-bit unsigned integer representing the channel on assigned to the connection. The unit of measure is in Hz.

Upstream_VPI is an 8-bit unsigned integer representing the ATM Virtual Path Identifier that is used for upstream transmission over the Dynamic Connection.

Upstream_VCI is an 16-bit unsigned integer representing the ATM Virtual Channel Identifier that is used for upstream transmission over the Dynamic Connection.

MAC_Flag_Set is an 5 bit field representing the MAC Flag set assigned to the connection. In the OOB downstream SL-ESF frame payload structure, each set of three bytes, denoted by Rxa- Rxc, comprise a flag set. These eight flag sets are assigned the numbers 0..7. In the case of a 3.088 Mbit/s upstream channel, two successive flag sets are required to define a 3ms period. In this case, this parameter represents the first of two successively assigned flag sets. In the case of a 3.088Mbit/s OOB downstream, two successive SL-ESF frames define the 3ms interval. The Rxa-Rxc bytes of the first frame represent flag sets 0..7 while the Rxa-Rxc bytes of the second frame represent flag sets 8..15.

enum Upstream_Rate	{	Upstream_256K,
		Upstream_1.544M,
		Upstream_3.088M,
		Reserved 3..7
	};	

Number of Slots Defined

Number_Slots_Defined is an 8-bit unsigned integer that represents the number of slot assignments contained in the message. The unit of measure is slots.

Slot Number

Slot_Number is a 13-bit unsigned integer that represents the Contentionless based Slot Number assigned to the DHCT.

Contentionless Start

Contentionless_Start is a 16 bit unsigned integer that represents the starting upstream slot within the contentionless access region that is assigned to the DHCT. The DHCT may use the next Frame_Length slots of the contentionless access regions.

Contentionless Distance

Contentionless_Distance is 16 bit unsigned integer that represents the distance in upstream slots between additional slots assigned to the DHCT. The DHCT is assigned all slots that are a multiple of Contentionless_Distance from the Contentionless_Start_Slot within the contentionless access region. The DHCT may use the next Frame_Length slots of the contentionless access regions from each of these additional slots.

Number Cyclic Slots Defined

Number_Cyclic_Slots Defined is a 16 bit unsigned integer that represents the number of slots assigned by the message. The unit of measure is in assigned slots.

2.3.4.4.2.2 <MAC> Connect Response Message

The <MAC> CONNECT RESPONSE MESSAGE is sent to the NMS from the DHCT in response to the <MAC> CONNECT MESSAGE. The message shall be transmitted on the upstream frequency specified in the <MAC> CONNECT MESSAGE.

Connect_Response_Message(){	Bits	Bytes	Bit Number / Description
Connection_ID	32	4	
}			

Connection ID

Connection_ID is a 32-bit unsigned integer representing a global connection Identifier for the DHCT Dynamic Connection.

2.3.4.4.2.3 <MAC> Connect Confirm Message

The <MAC> Connect Confirm message is sent from the NMS to the DHCT. Its usage is recommended when NMS validation of new connection is required.

Connect_Confirm_Message(){	Bits	Bytes	Bit Number / Description
Connection_ID	32	4	
}			

Connection ID

Connection_ID is a 32-bit unsigned integer representing a global connection Identifier for the DHCT Dynamic Connection.

2.3.4.4.2.4 <MAC> Reservation Request Message

Reservation_Request_Message (){	Bits	Bytes	Bit Number / Description
Reservation_ID	16	2	
Reservation_Request_Slot_Count	8	1	
}			

Reservation_ID

Reservation_ID is a 16 bit unsigned number representing a locally assigned identifier for the connection. This is used as a short identifier by the DHCT to identify the appropriate Reservation_Grant_Messages.

Reservation_Request_Slot_Count

Reservation_Request_Slot_Count is an 8 bit unsigned number representing the number of slots requested by the DHCT. This is the number of sequential slots that will be allocated in the reservation region of the upstream channel. The NMS will respond with the Reservation_Acknowledge_Message granting the request.

2.3.4.4.2.5 <MAC> Reservation Grant Message

The <MAC> RESERVATION GRANT MESSAGE is used to indicate to the DHCT which slots have been allocated in response to the Reservation_Request_Message. The DHCT identifies its entry in the Reservation_Grant_Message by comparing the Reservation_ID assigned to it by the Reservation_ID_Assignment_Message and the entries in the Reservation_Grant_Message.

The format of the message is given below.

Reservation_Grant_Message (){	Bits	Mnemonic
Reference_Slot	16	uimsbf
Number_Grants	8	uimsbf
for (i=1;i<=Number_Grants;i++) {		
Reservation_ID	16	uimsbf
Grant_Slot_Count	4	uimsbf
Remaining_Slot_Count	5	uimsbf
Grant_Control	2	uimsbf
Grant_Slot_Offset	5	uimsbf
}		
}		

Reference_slot

Reference_slot is an 16 bit unsigned number indicating the reference point for the remaining parameters of this message. This represents a physical slot of the upstream channel. Since the up-stream and down stream slots are not aligned, the NMS shall send this message in a

downstream slot such that it is received by the DHCT before the Reference_Slot exists on the upstream channel.

Number_grants

Number_Grants is an 8 bit unsigned number representing the number of grants contained within this message.

Reservation_ID

Reservation_ID is a 16 bit unsigned number representing a locally assigned identifier for the connection. This is used as a short identifier by the DHCT to identify the appropriate Reservation_Grant messages.

Grant_Slot_Count

Grant_Slot_Count is an 4 bit unsigned number representing the number of sequential slots currently granted for the upstream burst. Upon receipt of this message the DHCT is assigned Grant_Slot_Count sequential slots in the reservation access region of the upstream channel starting at the position indicated by the Reference_Slot and Grant_Slot_Offset values. A value of zero indicates that no slots are being granted. This would typically be the case in a response to a Reservation_Status_Request_Message

Remaining_Slot_Count

Remaining_Slot_Count is a 5 bit unsigned number representing the remaining slots to be granted by the NMS with subsequent grant messages. A value of 0x1f indicates that 31 or more slots will be made available in the future. A value of 0x0 indicates that no additional slots will be granted in the future and that the slots granted in this message represent the only remaining slots available for the connection. The DHCT should monitor this count to determine if sufficient slots remain to satisfy current needs. Should additional slots be required because of lost grant messages or additional demand, additional slots should be requested using the Reservation_Request message. Additional Reservation_Request_Messages shall be sent only when the Remaining_Slot_Count is less than 15. To minimize contention on the upstream channel, the Reservation_Request_Message may be sent in one of the slots granted by the Reservation_Grant_Message.

Grant_Control

Grant_Control is a 2 bit unsigned number coded as 0 (reserved for future use).

Grant_Slot_Offset

Grant_Slot_Offset is a 5 bit unsigned integer representing the starting slot to be used for the upstream burst. This number is added to the Reference_Slot to determine the actual physical slot. Upon receipt of this message the DHCT is assigned Grant_Slot_Count sequential slots in the reservation access region of the upstream channel.

2.3.4.4.2.6 *<MAC> Reservation ID Assignment Message*

The <MAC> Reservation ID Assignment Message is used to assign the DHCT a Reservation_ID. The DHCT identifies its entry in the Reservation_Grant_Message by comparing the Reservation_ID assigned to it by the Reservation_ID_Assignment_Message and the entries in the Reservation_Grant_Message.

The format of the message is given below.

Reservation_ID_Assignment_Message () {	Bits	Bytes	Bit Number / Description
Connection_ID	32	4	
Reservation_ID	16	2	
Grant_Protocol_Timeout	16	2	
}			

Connection ID

Connection_ID is a 32-bit unsigned integer representing a global connection identifier for the DHCT Dynamic Connection.

Reservation_ID

Reservation_ID is a 16 bit unsigned number representing a locally assigned identifier for the connection. This is used as a short identifier by the DHCT to identify the appropriate Reservation_Grant_Messages.

Grant_Protocol_Timeout

Grant_Protocol_Timeout is a 16 bit unsigned number representing the time in milliseconds that the DHCT should wait before verifying the status of pending grants. This parameter specifies the time that the DHCT should wait after sending the Reservation_Request_Message or after receiving the last Reservation_Grant_Message, with an entry addressed to the DHCT containing a nonzero Remaining_slot_count, before initiating a reservation status request. If the DHCT has pending grants and the timeout occurs, it should send the Reservation_Status_Request_Message to the NMS. The NMS will respond with the Reservation_Grant_Message (probably without granting any slots) to inform the DHCT of any remaining slots left to be granted. This allows the DHCT to correct any problems should they exist such as issuing an additional request for slots or waiting patiently for additional grants.

2.3.4.4.2.7 <MAC> Reservation ID Response Message

The <MAC> Reservation ID Response Message is used to acknowledge the receipt of the <MAC> Reservation_ID_Assignment message.

The format of the message is given below.

Reservation_ID_Response_Message () {	Bits	Bytes	Bit Number / Description
Connection_ID	32	4	
Reservation_ID	16	2	
}			

Connection ID

Connection_ID is a 32-bit unsigned integer representing a global connection identifier for the DHCT Dynamic Connection.

Reservation_ID

Reservation_ID is a 16 bit unsigned number representing a locally assigned identifier for the connection. This is used as a short identifier by the DHCT to identify the appropriate Reservation_Grant_Messages.

2.3.4.4.2.8 <MAC> Reservation Status Request

The <MAC> RESERVATION STATUS REQUEST Message is used to determine the status of the outstanding grants to be assigned by the NMS. This message is only sent after the Grant protocol timeout is exceeded. The NMS will respond with the Reservation_Grant_Message (possibly without granting any slots) to inform the DHCT of any remaining slots left to be granted. This allows the DHCT to correct any problems should they exist such as issuing an additional request for slots or waiting patiently for additional grants.

The format of the message is given below.

Reservation_Status_Request_Message (){	Bits	Bytes	Bit Number / Description
Reservation_ID	16	2	
Remaining_Request_Slot_Count	8	1	
}			

Reservation_ID

Reservation_ID is a 16 bit unsigned number representing a locally assigned identifier for the connection. This is used as a short identifier by the DHCT to identify the appropriate Reservation_Grant_Messages.

Remaining_Request_Slot_Count

Remaining_Request_Slot_Count is an 8 bit unsigned number representing the number of slots that the DHCT is expecting to be granted.

2.3.4.4.2.9 <MAC> Release Message

The <MAC> **Release Message** is sent from the NMS to the DHCT to terminate a previously established connection.

Release_Message(){	Bits	Bytes	Bit Number / Description
Number_of_Connections for(i=0;i<Number_of_Connections; i++){	8	1	
Connection_ID }	32	4	
}			

Number_of_Connections

Number_of_Connections is an 8-bit unsigned integer representing the number of Connection Identifiers listed in the <MAC> Release Message.

Connection ID

Connection_ID is a 32-bit unsigned integer representing a global connection Identifier for the DHCT Dynamic Connection.

2.3.4.4.2.10 <MAC> Release Response Message

The <MAC> RELEASE RESPONSE MESSAGE is sent by the DHCT to the NMS to acknowledge the release of a connection. The format of the message is shown in the Figure.

Release_Response_Message (){	Bits	Bytes	Bit Number / Description
Connection_ID }	32	4	

Connection ID

Connection_ID is a 32-bit unsigned integer representing the global connection Identifier used by the DHCT for this connection.

2.3.4.4.2.11 <MAC> Idle Message

The <MAC> **Idle Message** is sent by the DHCT within the DHCT to the NMS at predefined intervals when upstream connection buffers are empty.

Idle_Message(){	Bits	Bytes	Bit Number / Description
Idle_Sequence_Count	8	1	
Power_Control_Setting	8	1	
}			

Idle Sequence Count

Idle_Sequence_Count is a 8-bit unsigned integer representing the count of <MAC> IDLE MESSAGES transmitted while the DHCT is Idle.

Power Control Setting

Power_Control_Setting is a 8-bit unsigned integer representing the absolute power attenuation that the DHCT is using for upstream transmission.

2.3.4.4.3 Link Management Messages

2.3.4.4.3.1 <MAC> Transmission Control Message

The <MAC> TRANSMISSION CONTROL MESSAGE is sent to the DHCT from the NMS to control several aspects of the upstream transmission. This includes stopping upstream transmission, reenabling transmission from a DHCT or group of DHCTs and rapidly changing the upstream frequency being used by a DHCT or group of DHCTs. To identify a group of DHCTs for switching frequencies, the <MAC> TRANSMISSION CONTROL MESSAGE is sent in broadcast mode with the Old_Frequency included in the message. When broadcast with the Old_Frequency, the DHCT shall compare its current frequency value to Old_Frequency. When equal, the DHCT shall switch to the new frequency specified in the message. When not equal, the DHCT shall ignore the new frequency and remain on its current channel.

Transmission_Control_Message(){	Bits	Bytes	Bit Number / Description
Transmission_Control_Field		1	
Reserved	3		7..5
Stop_Upstream_Transmission	1		4:{no, yes}
Start_Upstream_Transmission	1		3:{no, yes}
Old_Frequency_Included	1		2:{no, yes}
Switch_Downstream_OOB_Frequency	1		1:{no, yes}
Switch_Upstream_Frequency	1		0:{no, yes}
if (Transmission_Control_Field == Switch_Upstream_Frequency && Old_Frequency_Included) {			
Old_Upstream_Frequency	32	4	
}			
if (Transmission_Control_Field == Switch_Upstream_Frequency) {			
New_Upstream_Frequency	32	4	
New_Upstream_Parameters		2	
New_Upstream_Channel_Number	3		7..5
Reserved	2		4..3
Upstream_Rate	3		2..0:{enum}
MAC_Flag_Set	5		7..3
Reserved	3		2..0
}			
if (Transmission_Control_Field == Switch_Downstream_OOB_Frequency && Old_Frequency_Included) {			
Old_Downstream_OOB_Frequency	32	4	
}			
if (Transmission_Control_Field == Switch_Downstream_OOB_Frequency) {			
New_Downstream_OOB_Frequency	32	4	
Downstream_Type	8	1	{enum}
}			
}			

Transmission Control Field

Transmission_Control_Field specifies the control being asserted on the channel.

It consists of the following subfields:

Stop_Upstream_Transmission is a Boolean when set indicates that the DHCT should halt its upstream transmission.

Old_Frequency_Included is a Boolean when set indicates that the Old Frequency value is included in the message and should be used to determine if a switch in frequency is necessary

Start_Upstream_Transmission is a Boolean when set indicates that the Network Interface Module should resume transmission on its upstream channel. The DHCT shall respond to the ranging and power calibration message regardless of the setting of the Start_Upstream_Transmission bit.

Switch_Upstream_Frequency is a Boolean when set indicates that a new upstream frequency is included in the message. Typically, the Switch_Upstream_Frequency and the Stop_Upstream_Transmission are set simultaneously to allow the DHCT to stop transmission and change channel. This would be followed by the <MAC> TRANSMISSION CONTROL MESSAGE with the start_upstream_transmission bit set.

Switch_Downstream_OOB_Frequency is a Boolean when set indicates that a new downstream OOB frequency is included in the message.

Old Upstream Frequency

Old_Upstream_Frequency is a 32-bit unsigned integer representing the frequency that should be used by the DHCT to compare with its current frequency to determine if a change in channel is required.

New Upstream Frequency

New_Upstream_Frequency is a 32-bit unsigned integer representing the reassigned upstream carrier center frequency. The unit of measure is Hz.

New Upstream Channel Number

New_Upstream_Channel_Number is a 3-bit unsigned integer that provides an identifier for the upstream channel.

Upstream Rate

Upstream_Rate is a 3-bit enumerated type indicating the data rate for the upstream connection.

```
enum Upstream_Rate {
    Upstream_256K,
    Upstream_1.544M,
    Upstream_3.088M,
    Reserved_3..7 };
```

MAC_Flag_Set

MAC_Flag_Set is a 5 bit field representing the MAC Flag set assigned to the connection. In the OOB downstream SL-ESF frame payload structure, each set of three bytes, denoted by Rxa- Rxc,, comprise a flag set. These eight flag sets are assigned the numbers 0..7. In the case of a 3.088 Mbit/s upstream channel, two successive flag sets are required to define a 3ms period. In this case, this parameter represents the first of two successively assigned flag sets. In the case of a 3.088Mbit/s OOB downstream, two successive SL-ESF frames define the 3ms interval. The Rxa-Rxc bytes of the first frame represent flag sets 0..7 while the Rxa-Rxc bytes of the second frame represent flag sets 8..15.

Old Downstream OOB Frequency

Old_Downstream_OOB_Frequency is a 32-bit unsigned integer representing the frequency that should be used by the DHCT to compare with its current frequency to determine if a change in channel is required.

New Downstream OOB Frequency

New_Downstream_OOB_Frequency is a 32-bit unsigned integer representing the reassigned downstream OOB carrier center frequency. The unit of measure is Hz.

Downstream_Type

Downstream_Type is an 8-bit enumerated type indicating the modulation format for the downstream connection.

enum	Downstream_Type	{	Reserved, QPSK_1.544, QPSK_3.088, Reserved 3..255	};
------	-----------------	---	--	----

2.3.4.4.3.2 <MAC> Reprovision Message

The <MAC> REPROVISION MESSAGE is sent by the NMS to the DHCT to reassign upstream resources (maintaining the originally requested QoS parameters at the establishment of the connection.) This message is intended for channel maintenance by the NMS to redistribute or reassign resources allocated to a DHCT.

Reprovision_Message () {	Bits	Bytes	Bit Number / Description
Reprovision_Control_Field		1	
Reserved	2		7..6
New_Downstream_IB_Frequency	1		5: {no,yes}
New_Downstream_OOB_Frequency	1		4: {no,yes}
New_Upstream_Frequency_Included	1		3: {no,yes}
New_Frame_Length_Included	1		2: {no,yes}
New_Cyclic_Assignment_Included	1		1: {no,yes}
New_Slot_List_Included	1		0: {no,yes}
if (Reprovision_Control_Field == New_Downstream_IB_Frequency) {			
New_Downstream_IB_Frequency	32	4	
}			
if (Reprovision_Control_Field == New_Downstream_OOB_Frequency) {			
{			
New_Downstream_OOB_Frequency	32	4	
Downstream_Type	8	1	{enum}
}			
if (Reprovision_Control_Field == New_Frequency_Included) {			
New_Upstream_Frequency	32	4	
New_Upstream_Parameters		2	
New_Upstream_Channel_Number	3		7..5
Reserved	2		4..3
Upstream_Rate	3		2..0: {enum}
MAC_Flag_Set	5		7..3
Reserved	3		2..0
}			
if (Reprovision_Control_Field == New_Frame_Length_Included) {			
New_Frame_Length	16	2	
}			
if (Reprovision_Control_Field == New_Slot_List_Included			
New_Cyclic_Assignment_Included) {			
Number_of_Connections	8	1	
}			
for(i=0;i<Number_of_Connections;i++) {			
Connection_ID	32	4	
if (Reprovision_Control_Field == New_Slot_List_Included) {			
Number_Slots_Defined	8	1	
for(i=0;i<Number_Slots_Assigned;			
i++){			
Slot_Number	13	2	
}			
}			
if (Reprovision_Control_Field ==			
New_Cyclic_Assignment_Included) {			
Contentionless_Start	16	2	
Contentionless_Dist	16	2	
Number_Cyclic_Slots_Defined	16	2	
}			
}			
}			

Reprovision Control Field

Reprovision_Control_Field specifies what modifications to upstream resources are included.

It consists of the following subfields:

New_Upstream_OOB_Frequency is a Boolean that indicates that a new downstream OOB frequency is specified in the message.

New_Upstream_IB_Frequency is a Boolean that indicates that a new downstream IB frequency is specified in the message. This field is reserved in order to maintain compatibility with DAVIC.

New_Upstream_Frequency_Include is a Boolean that indicates that a new upstream frequency is specified in the message.

New_Frame_Length_Include is a Boolean that indicates that a new upstream frame is specified in the message.

New_Slot_List_Include is a Boolean that indicates that a new slot list is specified in the message.

New_Cyclical_Assignment_Include is a Boolean that indicates that a new cyclical assignment is specified in the message.

New Downstream IB Frequency

New_Downstream_IB_Frequency is a 32-bit unsigned integer representing the reassigned downstream IB carrier center frequency. The unit of measure is Hz. This field is not expected to be used but is reserved for compatibility with DAVIC.

New Downstream OOB Frequency

New_Downstream_OOB_Frequency is a 32-bit unsigned integer representing the reassigned downstream OOB carrier center frequency. The unit of measure is Hz.

Downstream_Type

Downstream_Type is an 8-bit enumerated type indicating the modulation format for the downstream connection.

enum	Downstream_Type	{	Reserved, QPSK_1.544, QPSK_3.088, Reserved 3..255	};
------	-----------------	---	--	----

New Upstream Frequency

New_Upstream_Frequency is a 32-bit unsigned integer representing the reassigned upstream carrier center frequency. The unit of measure is Hz.

New Upstream Channel Number

New_Upstream_Channel_Number is a 3-bit unsigned integer that provides an identifier for the upstream channel.

Upstream Rate

Upstream_Rate is a 3-bit enumerated type indicating the data rate for the upstream connection.

enum Upstream_Rate	{	Upstream_256K,
		Upstream_1.544M,
		Upstream_3.088M,
		Reserved_3..7
	}	};

MAC_Flag_Set

MAC_Flag_Set is an 5 bit field representing the MAC Flag set assigned to the connection.

New Frame Length

New_Frame_Length is a 16-bit unsigned integer representing the size of the reassigned upstream Contentionless based frame. The unit of measure is in slots.

Number of Slots Defined

Number_Slots_Defined is an 8-bit unsigned integer that represents the number of slot assignments contained in the message. The unit of measure is slots.

Slot Number

Slot_Number is a 13-bit unsigned integer that represents the Contentionless based Slot Number assigned to the Network Interface Module.

Contentionless Start

Contentionless_Start is a 16 bit unsigned integer that represents the starting upstream slot within the contentionless access region that is assigned to DHCT. The DHCT may use the next Frame_Length slots of the contentionless access regions.

Contentionless Distance

Contentionless_Distance is 16 bit unsigned integer that represents the distance in upstream slots between additional slots assigned to the DHCT. The DHCT is assigned all slots that are a multiple of Contentionless_Distance from the Contentionless_Start_Slot within the contentionless access region. The DHCT may use the next Frame_Length slots of the contentionless access regions from each of these additional slots.

Number Cyclic Slots Defined

Number_Cyclic_Slots_Defined is a 16 bit unsigned integer that represents the number of slots assigned by the message. The unit of measure is in assigned slots.

2.3.4.4.3.3 <MAC> Link Management Response Message

The <MAC> LINK MANAGEMENT RESPONSE MESSAGE is sent by the DHCT to the NMS to indicate reception and processing of the previously sent Link Management Message. The format of the message is shown below..

Link_Management_Response_Message(){	Bits	Bytes	Bit Number / Description
Link_Management_Msg_Number	16	2	
}			

Link Management Message Number

Link_Management_Msg_Number is a 16-bit unsigned integer representing the previously received link management message. The valid values for Link_Management_Msg_Number are:

Message Name	Link_Management_Msg_Number
Transmission Control Message	Transmission Control Message Type Value
Reprovision Message	Reprovision Message Type Value

2.3.4.4.3.4 <MAC> Status Request Message

The STATUS REQUEST message is sent by the NMS to the DHCT to retrieve information about the DHCTs health, connection information and error states. The NMS can request either the address parameters, error information, connection parameters or physical layer parameters from the DHCT. The NMS can only request one parameter type at a time to a particular DHCT.

Status_Request_Message(){	Bits	Bytes	Bit Number / Description
Status_Control_Field		1	
Reserved	5		7..3
Status_Type	3		2..0: {enum}
}			

Status Control Field

Status_Control_Field is a 3 bit enumerated type that indicates the status information the DHCT should return

enum Status_Control_Field	{	Address_Params, Error_Params, Connection_Params, Physical_Layer_Params, Reserved 4..7	};
---------------------------	---	---	----

2.3.4.4.3.5 <MAC> Status Response Message

The <MAC> STATUS RESPONSE MESSAGE is sent by the DHCT in response to the <MAC> STATUS REQUEST MESSAGE issued by the NMS. The contents of the information provided in this message will vary depending on the request made by the NMS and the state of the DHCT.

Status_Response_Message(){	Bits	Bytes	Bit Number/ Description
DHCT_Status		4	
Reserved	29		31..3
Network_Address_Registered	1		2:{no, yes}
Default_Connection_Established	1		1:{no, yes}
Calibration_Operation_Complete	1		0:{no, yes}
Response_Fields_Included		1	
Reserved	4		7..4
Address_Params_Included	1		3:{no, yes}
Error_Information_Included	1		2:{no, yes}
Connection_Params_Included	1		1:{no, yes}
Physical_Layer_Params_Included	1		0:{no, yes}
if (Response_Fields_Included == Address_Params_Included) {			
NSAP_Address	160	20	
MAC_Address	48	6	
}			
if (Response_Fields_Included == Error_Information_Included) {			
Number_Error_Codes_Included	8	1	
for(i=0;			
i<Number_Error_Codes_Included;i++){			
Error_Param_Code	8	1	
Error_Param_Value	16	2	
}			
}			
if (Response_Fields_Included == Connection_Params_Included)			
{			
Number_of_Connections	8	1	
for(i=0;			
i<Number_of_Connections;i++){			
Connection_ID	32	4	
}			
}			
if (Response_Fields_Included ==			
Physical_Layer_Params_Included) {			
Power_Control_Setting	8	1	
Time_Offset_Value	16	2	
Upstream_Frequency	32	4	
Downstream_Frequency	32	4	
}			
}			

DHCT Status

DHCT_Status is a 32-bit field that indicates the current state of the DHCT. It contains the following subfields:

Network_Address_Registered indicates that the Network Interface Module has registered its Network Address with the Application Module.

Default_Connection_Established indicates that the Network Interface Module has been assigned Default Connection parameters.

Calibration_Operation_Complete indicates that the Network Interface Module has been successfully calibrated.

Response Fields Included

Response_Fields_Included is an 8 bit unsigned integer that indicates what parameters are contained in the upstream status response.

NSAP Address

NSAP_Address is a 20 byte address assigned to the DHCT.

MAC Address

MAC_Address is a 6 byte address assigned to the DHCT.

Number of Error Codes Included

Number_Error_Codes_Included is an 8-bit unsigned integer that indicates the number of error codes are contained in the response.

Error Param Code

Error_Param_Code is a 8-bit enumerated type representing the type of error reported by the DHCT.

```
enum Error_Param_Code {
    Framing_Bit_Error_Count,
    Slot_Configuration_CRC_Error_Count,
    Reed_Solomon_Error_Count,
    ATM_Packet_Loss_Count
    Reserved 4..255 };
```

Error Param Value

Error_Param_Value is an 16-bit unsigned integers representing error counts detected by the DHCT.

Number of Connections

Number_of_Connections is an 8-bit unsigned integer that indicates the number of connections that are specified in the response.

Connection ID

Connection_ID is a 32-bit unsigned integer representing the global connection Identifier used by the DHCT for this connection.

Power Control Setting

Power_Control_Setting is a 8-bit unsigned integer representing the actual power used by the DHCT for upstream transmission. Unit of measure is 0.5 dB μ V.

Time Offset Value

Time_Offset_Value is a 16-bit signed integer representing a relative offset of the upstream transmission timing. A negative value indicates an adjustment forward in time. A positive value indicates an adjustment back in time. The unit of measure is 100 nsec.

Upstream Frequency

Upstream_Frequency is a 32-bit unsigned integer representing the channel on assigned to the connection. The unit of measure is in Hz.

Downstream Frequency

Downstream_Frequency is a 32-bit unsigned integer representing the Frequency where the connection resides. The unit of measure is in Hz.

2.3.4.4.4 MAC message timeouts

The minimum time that the NMS will wait for a response from the DHCT varies with the message type as follows in Table 2-7:

Table 2-7 MAC Message Timeouts

Message	Timeout
Ranging & Power Calibration Response Message:	2 seconds
Connect Response Message:	10 seconds
Reservation ID Response Message	None
Release Message	10 seconds (1 retry)
Transmission Control Message	10 seconds (no retries)
Status Response Message	2 \times Idle period

The modulator expects to receive <MAC> Idle messages from each settop periodically, according to the Idle period provided in the NMS provisioning parameter screen. The QPSK modulator will wait 2 idle periods before sending a <MAC> Status Request message. The control field of the <MAC> Status Request Message will indicate a request for connection parameters. If the settop doesn't send a response after 3 <MAC> Status Request Messages, all of its connections are released at the modulator. Additionally, if the settop sends back connection parameters that contain connection IDs the modulator didn't assign, a <MAC> Release message is sent to release the connection(s).